

INSTALLATION INSTRUCTIONS

Fan Coil Unit Of Duct Type

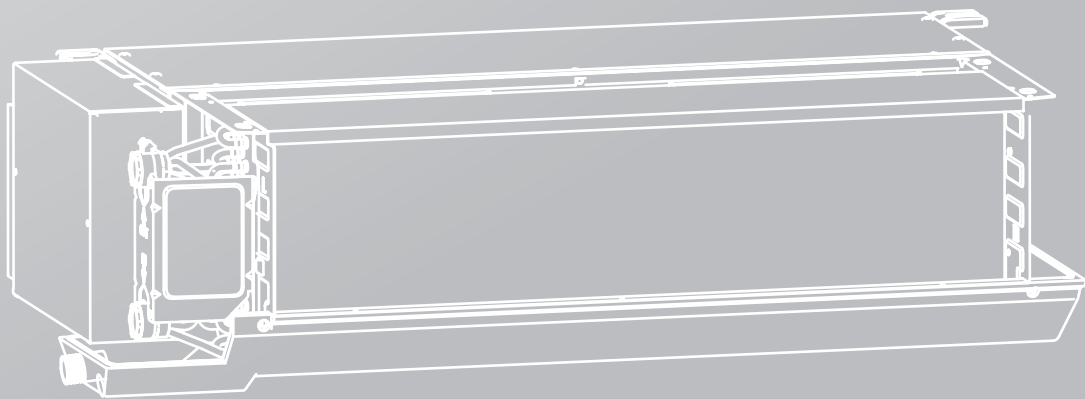

Thank you very much for purchasing our product,
Before using your unit , please read this manual carefully and keep it for future reference.
The figure shown in this manual is for reference only and may be slightly different from the actual product.



RECOGNIZE THIS SYMBOL AS AN INDICATION OF IMPORTANT SAFETY INFORMATION

⚠ WARNING

These instructions are intended as an aid to qualified licensed service personnel for proper installation, adjustment and operation of this unit. Read these instructions thoroughly before attempting installation or operation. Failure to follow these instructions may result in improper installation, adjustment, service or maintenance possibly resulting in fire, electrical shock, property damage, personal injury or death.

CONTENTS

1 PRECAUTIONS	01
2 INSTALLATION INFORMATION	02
3 FUNCTIONS & FEATURES	02
4 ACCESSORIES	02
5 OPERATION RANGE	02
6 PARTS NAMES	03
7 INSTALLATION	03
8 PIPE CONNECTION	06
9 INSTALLATION DRAINAGE PIPE	06
10 WIRING	06

1 PRECAUTIONS

- Be sure to be in conformity with the local, national and international laws and regulations.
- Read "PRECAUTIONS" carefully before installation.
- The following precautions include important safety items. Observe them and never forget.
- Keep this manual in a handy place for future reference.
- Before out from factory, FAN COIL UNIT (AIR UNITS) has passed Fan Coil Overpressure Resistant Test, Statically and Dynamically Balanced Adjustment, Noise Test, Air (cool) Volume Test, Electric Property Test, Outline Quality Detection.

NOTE

The safety precautions listed here are divided into two categories. In either case, important safety information is listed which must be read carefully.

WARNING

Failure to observe a warning may result in death.

CAUTION

Failure to observe a caution may result in injury or damage to the equipment.

NOTE

After completing the installation, make sure that the unit operates properly during the start-up operation. Please instruct the customer on how to operate the unit and keep it maintained.

WARNING

- Be sure only trained and qualified service personnel to install, repair or service the equipment.
Improper installation, repair, and maintenance may result in electric shocks, short-circuit, leaks, fire or other damage to the equipment.
- Install according to this installation instructions strictly. If installation is defective, it will cause water leakage, electrical shock and fire.
- When installing the unit in a small room, take measures against to keep refrigerant concentration from exceeding allowable safety limits in the event of refrigerant leakage. Contact the place of purchase for more information. Excessive refrigerant in a closed ambient can lead to oxygen deficiency.

WARNING

- Use the attached accessories parts and specified parts for installation.
otherwise, it will cause the set to fall, water leakage, electrical shock and fire.
- The appliance must be installed 2.3m above floor.
- The appliance shall not be installed in the laundry.
- Before obtaining access to terminals, all supply circuits must be disconnected.
- The appliance must be positioned so that the plug is accessible.
- The enclosure of the appliance shall be marked by word, or by symbols, with the direction of the fluid flow.
- For electrical work, follow the local national wiring standard, regulation and this installation instructions. An independent circuit and single outlet must be used.
If electrical circuit capacity is not enough or defect in electrical work, it will cause electrical shock fire.
- Use the specified cable and connect tightly and clamp the cable so that no external force will be acted on the terminal.
If connection or fixing is not perfect, it will cause heat-up or fire at the connection.
- Wiring routing must be properly arranged so that control board cover is fixed properly.
If control board cover is not fixed perfectly, it will cause heat-up at connection point of terminal, fire or electrical shock.
- If the supply cord is damaged, it must be replaced by the manufacture or its service agent or a similarly qualified person in order to avoid a hazard.
- An all-pole disconnection switch having a contact separation of at least 3mm in all poles should be connected in fixed wiring.
- When carrying out piping connection, take care not to let air substances go into refrigeration cycle.
Otherwise, it will cause lower capacity, abnormal high pressure in the refrigeration cycle.
- Do not modify the length of the power supply cord or use of extension cord, and do not share the single outlet with other electrical appliances.
Otherwise, it will cause fire or electrical shock.
- If the water leaks during installation, ventilate the area immediately.
- After completing the installation work, check that the water does not leak.
- The cool water in the unit is not lower than 3°C, hot water is not higher than 80°C. Water in the unit must clean, air quality must meet to the standard of PH=6.5~7.5.

⚠ CAUTION

- Before installing the unit, it is necessary to check whether the ground wire is charged. If it is, the unit shall not be installed before correction.
- Ground the air conditioner.
Do not connect the ground wire to gas or water pipes, lightning rod or a telephone ground wire. Incomplete grounding may result in electric shocks.
- Be sure to install an earth leakage breaker.
Failure to install an earth leakage breaker may result in electric shocks.
- Connect the outdoor unit wires, then connect the indoor unit wires.
You are not allowed to connect the air conditioner with the power source until wiring and piping of the air conditioner is done.
- While following the instructions in this installation manual, install drain piping in order to ensure proper drainage and insulate piping in order to prevent condensation.
Improper drain piping may result in water leakage and property damage.
- Install the indoor and outdoor units, power supply wiring and connecting wires at least 1 meter away from televisions or radios in order to prevent image interference or noise.
Depending on the radio waves, a distance of 1 meter may not be sufficient enough to eliminate the noise.
- This appliance is not intended for use by persons (including children) with reduced physical, sensory or mental capabilities, or lack of experience and knowledge, unless they have been given supervision or instruction concerning use of the appliance by a person responsible for their safety.



DISPOSAL: Do not dispose this product as unsorted municipal waste. Collection of such waste separately for special treatment is necessary.

Disconnect the power supply before cleaning and maintenance. Use dry cloth to clean the unit.

Don't install the air conditioner in the following locations:

- There is petrolatum existing.
- There is salty air surrounding (near the coast).
- There is caustic gas (the sulfide, for example) existing in the air (near a hot spring).
- The Volt vibrates violently (in the factories).
- In buses or cabinets.
- In kitchen where it is full of oil gas.
- There is strong electromagnetic wave existing.
- There are inflammable materials or gas.
- There is acid or alkaline liquid evaporating.
- Other special conditions.

2 INSTALLATION INFORMATION

- To install properly, please read this "Owner's & Installation manual" at first.
- The air conditioner must be installed by qualified persons.
- When installing the indoor unit or its tubing, please follow this manual as strictly as possible.
- If the air conditioner is installed on a metal part of the building, it must be electrically insulated according to the relevant standards to electrical appliances.
- When all the installation work is finished, please turn on the power only after a thorough check.
- Regret for no further announcement if there is any change of this manual caused by product improvement.

3 FUNCTIONS & FEATURES

- Nested in the ceiling, space-saving and noble.
- High capacity of cooling / heating performance, high efficiency and energy-saving.
- Adjust the indoor temperature rapidly and averagely.
- Low noise design.
- The air outlet is laid out in the way you desire.

4 ACCESSORIES

Table 4-1

Accessory Name	Qty.	Sharp	Purpose
Owner's & installation manual	1	This manual	———

5 OPERATION RANGE

Use the system in the following temperature for safe and effective operation.

Table 5-1

Temperature Mode	Room temperature	Water inlet temperature
Cooling operation	17°C~30°C	3°C~30°C
Heating operating (cooling only type without)	17°C~30°C	30°C~75°C
Dehumidification operation	17°C~30°C	3°C~30°C

NOTE

- If air conditioner is used outside the above conditions, it may cause the unit to function abnormally.
- The phenomenon is normal that the surface of air conditioning may condense water when the relative larger humidity in room, please close the door and window.
- Optimum performance will be achieved within these operating temperature range.
- Water system operating pressuer: Max: 1.6MPa, Min: 0.15MPa.

6 PARTS NAMES

The above figures is an instance models, which would be different from the one that you purchase.

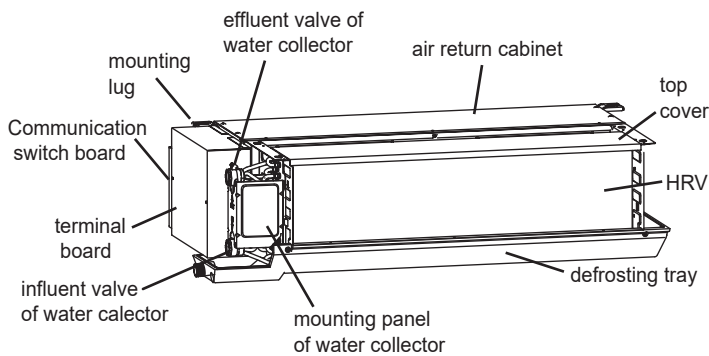

Two cochleate

Fig.6-1

7 INSTALLATION

7.1 Installing site

- Install the unit where enough space of installation and maintenance is available.
- Install the unit where the ceiling is horizontal and enough for bearing the weight of the indoor unit.
- Install the unit where the air inlet and outlet are not baffled and are the least affected by external air.
- Install the unit where the supply air flow can be sent to all parts in the room.
- Install the unit where it is easy to lead out the connective pipe and the drain pipe.
- Install the unit where connotative heat is emitted from a heat source directly.

CAUTION

Installing the equipment in any of the following places may lead to faults of the equipment (if that is inevitable, consult the supplier):

- The site contains mineral oils such as cutting lubricant.
- Seaside where the air contains much salt.
- Hot spring area where corrosive gases exist, e.g., sulfide gas.
- Factories where the supply voltage fluctuates seriously.
- Inside a car or cabin.
- Place like kitchen where oil permeates.
- Place where strong electromagnetic waves exist.
- Place where flammable gases or materials exist.
- Place where acid or alkali gases evaporate.
- Other special environments.

Precautions before installation

- Decide the correct way of conveying the equipment.
- Try to transport this equipment with the original package.
- If the air conditioner needs to be installed on a metal part of the building, electric insulation must be performed, and the installation must meet the relevant technical standards of electric devices.
- Before installing the unit, be sure to confirm with the user whether there are wires, water pipes, air pipes and so on in the wall or ground of the installation site to avoid accidents due to damage.

7.2 Installing the fan coil units

Confirm the dimensions of the indoor unit against the following figure.

Install $\Phi 10$ pendant bolts (4 bolts)

- The intervals of the pendant bolts are shown in the following figure.
- Use the $\Phi 10$ pendant bolts.
- The treatment of the ceiling varies between buildings. For detailed measures, negotiate with the construction and fit-out staff.
- Scope of dismantling the ceiling. Please keep the ceiling horizontal. Reinforce the beams and girders of the ceiling lest vibration of the ceiling.

- Cut off the beams and girders of the ceiling.
- Reinforce the cut-off part, beams and girders of the ceiling.
- After the main body is suspended, work on the pipes and wires in the ceiling. Decide the lead-out direction of the pipes after selecting the installation site. Especially, in a circumstance where a ceiling is available, extend the refrigerant pipe, drain pipe, indoor/outdoor connection wires and wire controller lines to the connection position before suspending the unit.

7.2.1 Procedure of installing the pendant bolts

- Base on the unit structure, please set the screw-pitch according to the size of the following figures:
 - Wooden structure
Put rectangular sticks across the beams, and set pendant bolts.

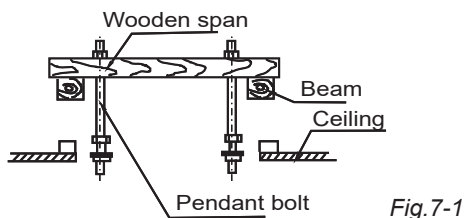

Fig.7-1

- Old concrete roughcast
Use embedded bolts and embedded pulling plugs.

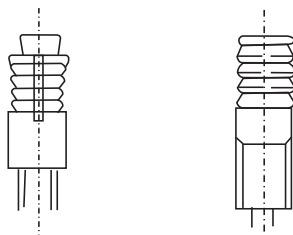

Fig.7-2

- Steel beam and girder structure
Set and use supportive angle steel.

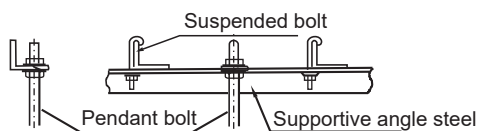

Fig.7-3

7.2.2 Space requirement

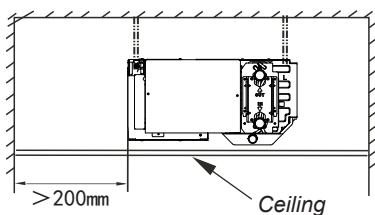

Fig.7-7

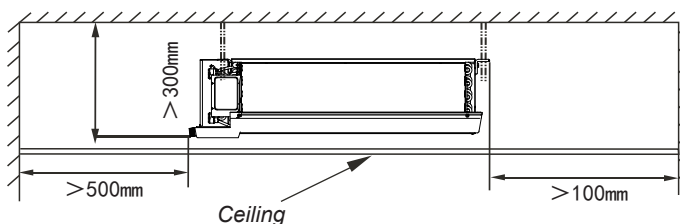

Fig.7-8

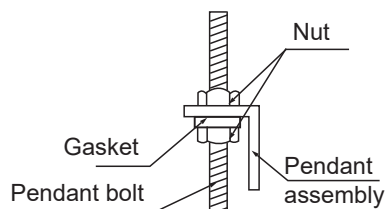

Fig.7-4

- New concrete roughcast
Set it with embedded bushes or embedded bolts.

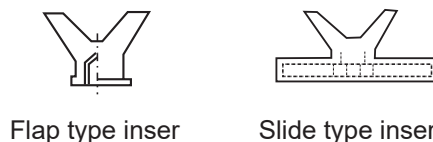

Fig.7-5

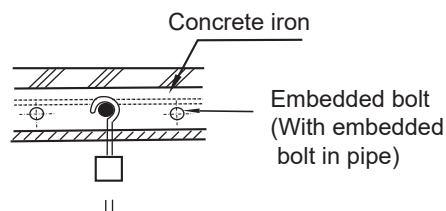

Fig.7-6

- Suspending the indoor unit
 - Use tools such as pulleys to hoist the indoor unit to the pendant bolt.
 - Use tools such as gradimeter to settle the indoor unit horizontally. Lack of horizontality may cause water leak.
- Connect the duct
The duct length is determined according to the external static pressure.
- Install the wire control switch
For installation of the wire control switch, see the installation manual of the wire controller.

7.2.3 Sample unit specification figure

The quantities of the fans and motors are only for reference, please prevail in kind!

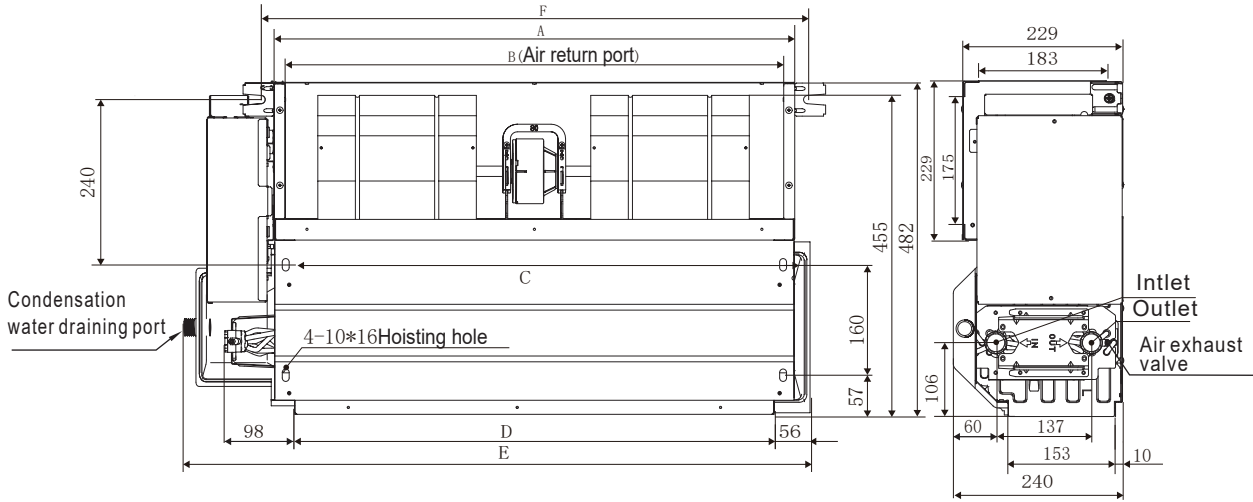

Fig.7-9.1

Table 7-1

Size \ Model	200-Model	300-Model	400-Model 500-Model	600-Model	700-Model	800-Model 1000-Model	1200-Model	1400-Model
A	475	620	755	850	1025	1215	1505	1745
B	443	588	723	818	993	1183	1473	1713
C	443	588	723	818	993	1183	1473	1713
D	415	560	695	790	965	1155	1445	1685
E	627	772	907	1002	1177	1367	1657	1897
F	513	658	793	888	1063	1253	1543	1783

NOTE

- The above figures is an instance models, which would be different from the one that you purchase.
- The broken lines in above figures for illustrate the dimension of air return box. (Lower side air return box and rear air return box)
- If you need to order air return box from us, please be specific describe which kind you need.

8 PIPES CONNECTION

- With air release valve, the other side is water inlet pipe.
- When connect water collector, set the tightening torque to 6180~7540N.cm(630~770kgf.cm), and use a spanner to tighten it as shown in Figure.
- The diameter of connective junction in water inlet pipe and water outlet pipe is RC3/4 taper pipe thread inside.
- The diameter of condensate pipe is ZG3/4 taper pipe thread outside.

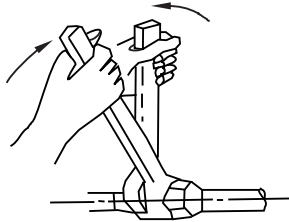

Fig.8-1

9 INSTALLING DRAINAGE PIPE

- Install the drain pipe of the fan coil unit
Before out from factory, the scupper adopts the pipe thread.

NOTE

- Be sure to perform heat insulation for the drain pipe of the indoor unit. Otherwise, condensate will occur. The joint of the indoor unit should also undergo heat insulation treatment.
- When performing the pipes connection, use the rigid PVC binder, and make sure that no leak exists.
- Same as the joint of the indoor unit. Be careful not to apply force at the pipe side of the indoor unit.

NOTE

- The downward gradient of the drain pipe should be higher than (1/100), without bend in the middle.
- The total length of the drain pipe when pulled out transversely shall not exceed 20m, when the pipe is over long, a prop stand must be installed prevent winging.
- The centralized pipes should be distributed against the figure shown on the right side.

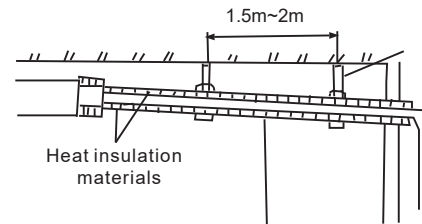

Downward gradient is over 1/100

Fig.9-1

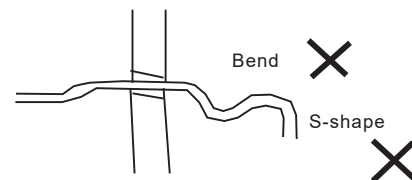
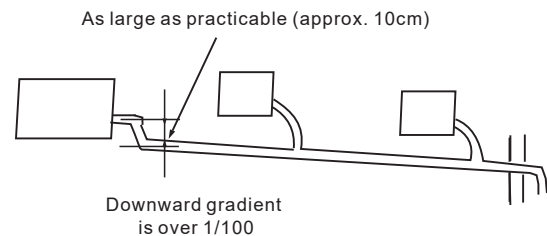

Fig.9-2



Downward gradient is over 1/100

Fig.9-3

Drain test

- Before the test, ensure that the drain pipes are smooth and the adapters are sealed.
- Newly built rooms should undergo the drain test before the ceiling is laid.

10 WIRING

CAUTION

- The air conditioner should use separate power supply with rated voltage.
- The external power supply to the air conditioner should have ground wiring, which is linked to the ground wiring of the indoor and outdoor unit.
- The wiring work should be done by qualified persons according to circuit drawing.
an all-pole disconnection device which has at least 3mm separation distance in all pole and a residual current
- device(RCD)with the rating of above 10mA shall be incorporated in the fixed wiring according to the national rule.
- The appliance shall be installed in accordance with national wiring regulations.
- Be sure to locate the power wiring and the signal wiring well to avoid cross-disturbance.
- Do not turn on the power until you have checked carefully after wiring.

Table 10-1

AIR FLOW(CFM)		200~1400
POWER	PHASE	1-phase
	FREQUENCY AND VOLT	220-240V~ 50Hz
CIRCUIT BREAKER/FUSE(A)		15/15
INDOOR UNIT POWER WIRING(mm ²)	BELOW 50M	Twisted pairwire: 1.5
GROUND WIRING(mm ²)		1.5

The power cord type designation is H05RN-F or above.

10.1 Wiring Diagram

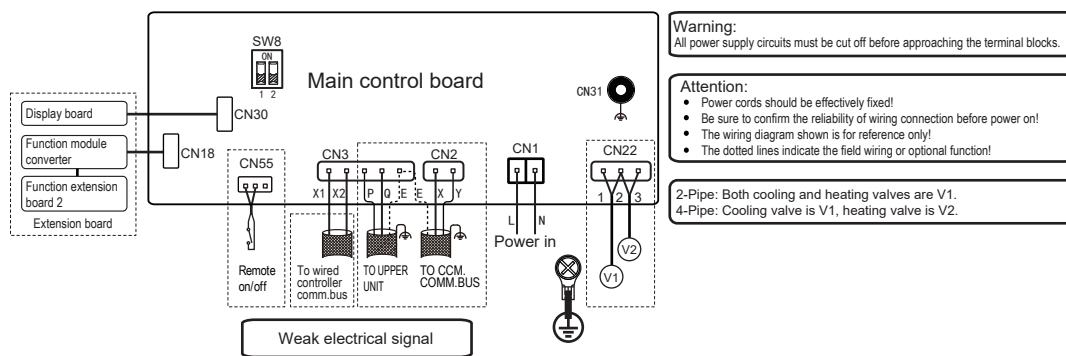

10.2 The default model of DC fan coil is set as 12Pa when leaving the factory. Clients can dial to the responding position to choose the model and static pressure according to the nameplate and actual static pressure requirements of the models and static dial code table .

static dial code table :

STATIC PRESSURE	Default 12Pa (Subject to the setting of wire controller)	12Pa	30Pa	50Pa
SW8	ON 	ON 	ON 	ON

10.3 Fault and Protection

Fault Definition, Code, Trigger/Clear Condition, Level

NO.	Fault definition	Applicable models	Classification Sub fault	New fault code (V11 version)	Subcode (V11)	Failure class (L1>L2>L3)
1	Fan failure	Protection fault	J0	1	Several times motor failures within 60 minutes	L1
2	Fan failure	Forced shutdown failure	Jy	Z	One time motor failure	L2
3	Fan failure	Forced shutdown failure	J4	5	Motor mismatch	L2
4	Water level fault (reserved)	Forced shutdown failure	b3	4	Water pump 1 body failure	L2
5	Water level fault (reserved)	Forced shutdown failure	b3	5	Water pump 2 body failure	L2
6	Water level fault	Forced shutdown failure	b3	6	Water level switch alarm failure	L2
7	EEPROM failure	Electrical control protection fault	P7	1	EEPROM failure	L2
8	EEPROM fault (reserved)	Electrical control protection fault	P7	2	Panel E side failure	L2
9	Air intake sensor failure	Sensor failure	E2	4	T1 sensor failure	L2
10	T2A sensor failure	Sensor failure	F0	1	T2A sensor failure	L3
11	T2B sensor failure	Sensor failure	F2	1	T2B sensor failure	L3
12	Dial code setting error	Installation failure	U1	1	Model not set	L2
13	Dial code setting error	Installation failure	U1	2	Capacity not set	L2
14	The communication between the main control and the module is faulty	Communication failure	C4	1	Communication failure between main control and drive module	L2
15	Indoor unit and external board communication failure	Communication failure	C6	1	Indoor unit and panel/display panel communication failure	L3

NO.	Fault definition	Applicable models	Classification Sub fault	New fault code (V11 version)	Subcode (V11)	Failure class (L1>L2>L3)
16	Indoor unit and external board communication failure	Communication failure	C7	8	Indoor unit and expansion board 2 communication failure	L2
17	Indoor unit and external board communication failure	Communication failure	C7	9	The communication between the Indoor unit and the adapter plate is faulty	L2
18	Humidity sensor failure (reserved)	Non-stop failure	EA	2	Humidity sensor failure	L3
19	Indoor unit and wired control communication failure	Communication failure	C5	1	Indoor unit and wired control communication failure	L3
20	Controller and panel sensor failure(reserved)	Non-stop failure	E3	1	Wired controller temperature sensor failure	L3
21	Controller and panel sensor failure (reserved)	Non-stop failure	E3	3	External temperature sensor failure	L3
22	Out of range	Status class failure	P0	2	Anti-freezing protection	L3
23	Out of range	Status class failure	P0	1	Water temperature is too high	L3
24	Remote shutdown	Warning class	d6	1	Remote shutdown	L3

💡 NOTE

- L1, L2, L3 means failure class, L1 fault shutdown, not recoverable; L2 fault shutdown, recoverable; L3 Fault alert, unit maintains minimum function operation.
- The "Jyz"("y" and "z" represent specific values) in the fan failure 2 means fan failure, different values represent different fan failure.
- For the DC ducted fan coil unit, there is no No. 10 T2A sensor failure and No. 11 T2B sensor failure.

10.4 Tables

MODEL: MKT3-V200G12-CL、MKT3-V200G12-CR			
Information to identify the model(s) to which the information relation:			
Item	Symbol	Value	Unit
Cooling capacity(sensible)	Prated,c	1.83	kW
Cooling capacity(latent)	Prated,c	0.62	kW
Heating capacity	Prated,h	2.68	kW
Total electric power input	Pelec	0.017	kW
Sound power level(per speed setting,if applicable)	LWA	53/47/39.5	dB
contact details			

MODEL:MKT3-V300G12-CL、MKT3-V300G12-CR

Information to identify the model(s)to which the information relation:

Item	Symbol	Value	Unit
Cooling capacity(sensible)	Prated,c	2.66	kW
Cooling capacity(latent)	Prated,c	0.69	kW
Heating capacity	Prated,h	3.95	kW
Total electric power input	Pelec	0.025	kW
Sound power level(per speed setting,if applicable)	LWA	56/46/38.5	dB
contact details			

MODEL:MKT3-V400G12-CL、MKT3-V400G12-CR

Information to identify the model(s)to which the information relation:

Item	Symbol	Value	Unit
Cooling capacity(sensible)	Prated,c	3.45	kW
Cooling capacity(latent)	Prated,c	0.80	kW
Heating capacity	Prated,h	5.00	kW
Total electric power input	Pelec	0.035	kW
Sound power level(per speed setting,if applicable)	LWA	57/51/44	dB
contact details			

MODEL:MKT3-V500G12-CL、MKT3-V500G12-CR

Information to identify the model(s)to which the information relation:

Item	Symbol	Value	Unit
Cooling capacity(sensible)	Prated,c	3.54	kW
Cooling capacity(latent)	Prated,c	1.01	kW
Heating capacity	Prated,h	5.50	kW
Total electric power input	Pelec	0.040	kW
Sound power level(per speed setting,if applicable)	LWA	58/53/44.5	dB
contact details			

MODEL:MKT3-V600G12-CL、MKT3-V600G12-CR

Information to identify the model(s)to which the information relation:

Item	Symbol	Value	Unit
Cooling capacity(sensible)	Prated,c	4.60	kW
Cooling capacity(latent)	Prated,c	1.25	kW
Heating capacity	Prated,h	6.90	kW
Total electric power input	Pelec	0.065	kW
Sound power level(per speed setting,if applicable)	LWA	64/57.5/49	dB
contact details			

MODEL:MKT3-V700G12-CL、MKT3-V700G12-CR			
Information to identify the model(s)to which the information relation:			
Item	Symbol	Value	Unit
Cooling capacity(sensible)	Prated,c	5.54	kW
Cooling capacity(latent)	Prated,c	0.96	kW
Heating capacity	Prated,h	7.60	kW
Total electric power input	Pelec	0.075	kW
Sound power level(per speed setting,if applicable)	LWA	65/60/54.5	dB
contact details			

MODEL:MKT3-V800G12-CL、MKT3-V800G12-CR			
Information to identify the model(s)to which the information relation:			
Item	Symbol	Value	Unit
Cooling capacity(sensible)	Prated,c	6.08	kW
Cooling capacity(latent)	Prated,c	1.94	kW
Heating capacity	Prated,h	9.40	kW
Total electric power input	Pelec	0.070	kW
Sound power level(per speed setting,if applicable)	LWA	63/58.5/52	dB
contact details			

MODEL:MKT3-V1000G12-CL、MKT3-V1000G12-CR			
Information to identify the model(s)to which the information relation:			
Item	Symbol	Value	Unit
Cooling capacity(sensible)	Prated,c	6.95	kW
Cooling capacity(latent)	Prated,c	2.10	kW
Heating capacity	Prated,h	11.00	kW
Total electric power input	Pelec	0.119	kW
Sound power level(per speed setting,if applicable)	LWA	67/61/50	dB
contact details			

MODEL:MKT3-V1200G12-CL、MKT3-V1200G12-CR			
Information to identify the model(s)to which the information relation:			
Item	Symbol	Value	Unit
Cooling capacity(sensible)	Prated,c	7.59	kW
Cooling capacity(latent)	Prated,c	2.49	kW
Heating capacity	Prated,h	11.83	kW
Total electric power input	Pelec	0.119	kW
Sound power level(per speed setting,if applicable)	LWA	68/58/49	dB
contact details			

MODEL:MKT3-V1400G12-CL、MKT3-V1400G12-CR

Information to identify the model(s) to which the information relation:

Item	Symbol	Value	Unit
Cooling capacity(sensible)	Prated,c	9.08	kW
Cooling capacity(latent)	Prated,c	2.03	kW
Heating capacity	Prated,h	12.67	kW
Total electric power input	Pelec	0.119	kW
Sound power level(per speed setting,if applicable)	LWA	69/65/61.5	dB
contact details			

16126200001126 V.B

