

INSTALLATION & OWNER'S MANUAL

Thank you very much for purchasing our product.
Before use, please carefully read this manual and keep it for future reference.

(Figure 1)

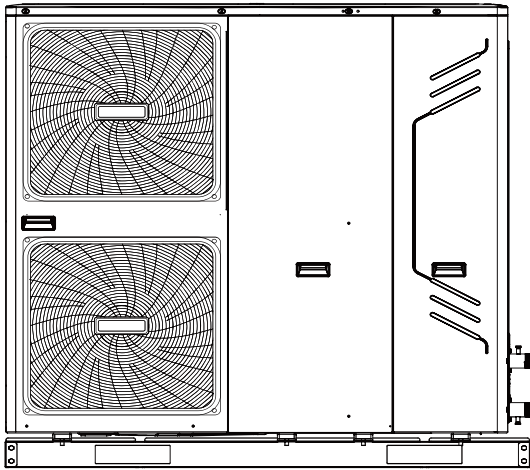

10/12/14/16 kW

(Figure 2)

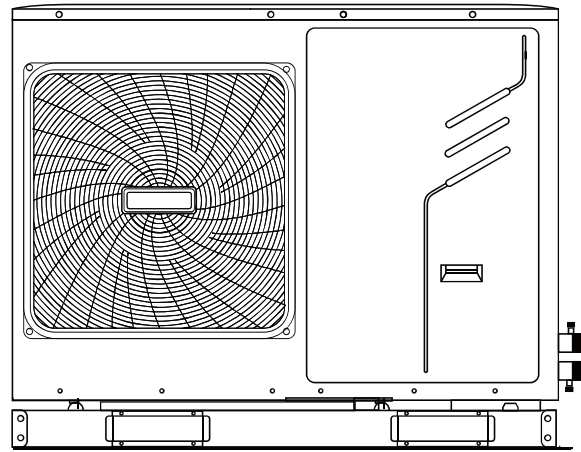

5/7/9 kW

Wiring diagram: 12-16kW(3-phase) for examples

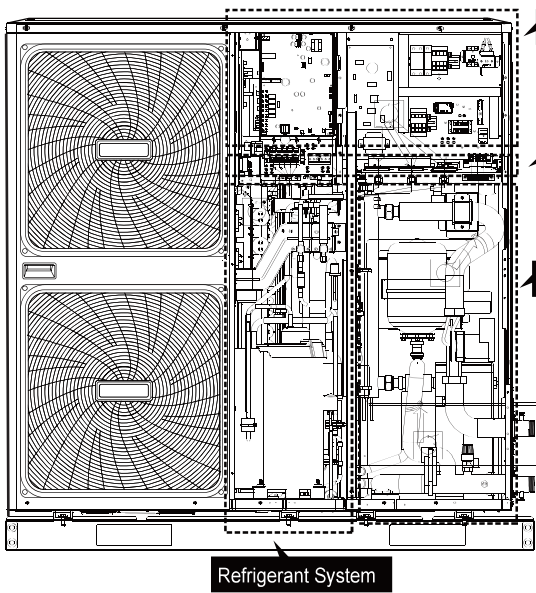

Electric Control System

Terminal Block

Hydraulic System

Refrigerant System

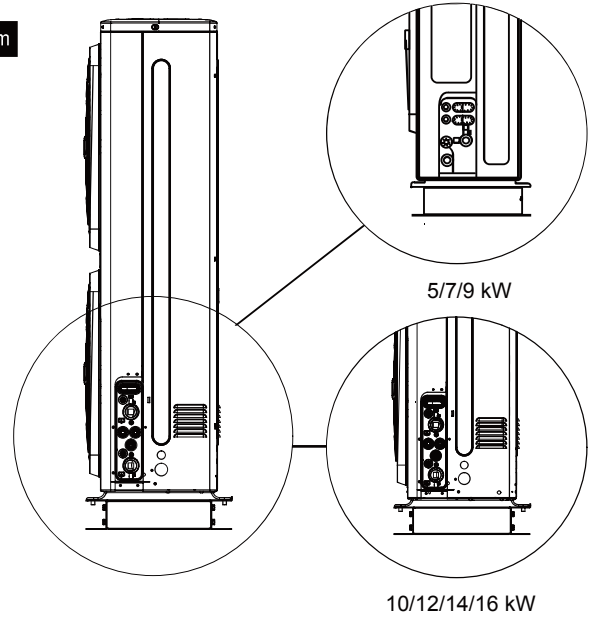

5/7/9 kW

10/12/14/16 kW

Please remove the hollow plate after installation.

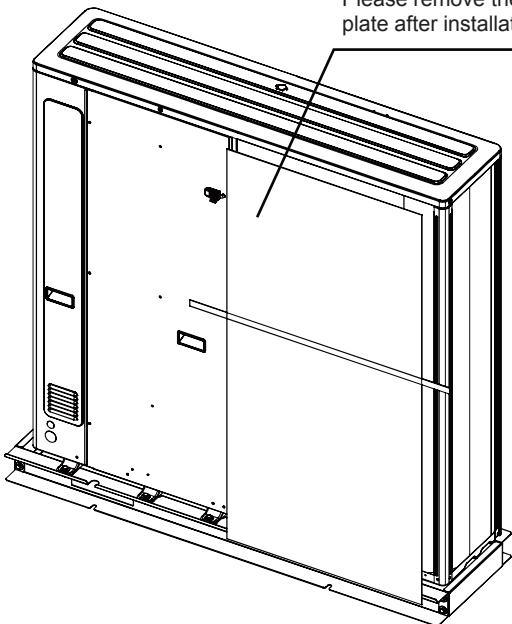

Installation fitting

X2

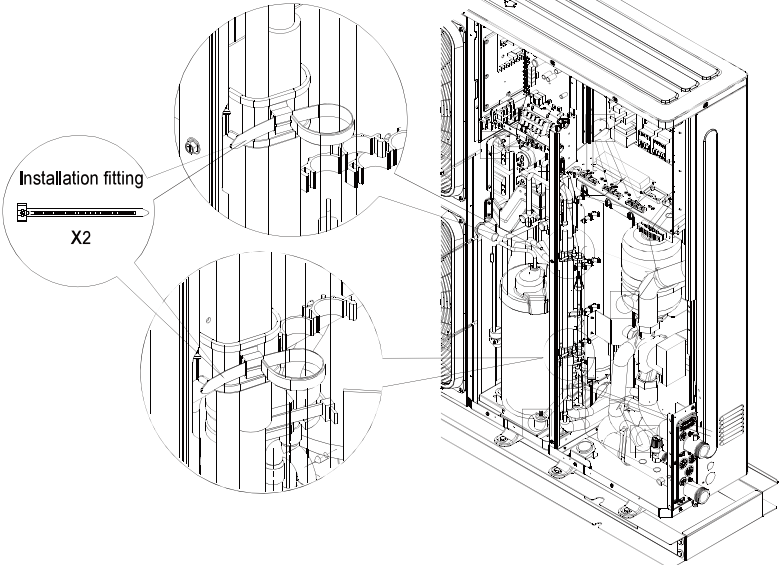

CONTENTS

PAGE

1	INTRODUCTION.....	1
2	ACCESSORIES.....	3
3	SAFETY CONSIDERATIONS.....	3
4	BEFORE INSTALLATION.....	4
5	IMPORTANT INFORMATION REGARDING THE REFRIGERANT USED.....	5
6	SELECTING INSTALLATION SITE.....	5
7	PRECAUTIONS ON INSTALLATION.....	6
8	TYPICAL APPLICATION EXAMPLES.....	8
9	OVERVIEW OF THE UNIT.....	19
10	START-UP AND CONFIGURATION.....	37
11	TEST RUN AND FINAL CHECK.....	50
12	MAINTENANCE AND SERVICE.....	50
13	TROUBLESHOOTING.....	50
14	TECHNICAL SPECIFICATIONS.....	57

1 INTRODUCTION

1.1 General information

- These units are used for both heating and cooling applications. They can be combined with fan coil units, floor heating applications, low temperature high efficiency radiators, domestic hot water tanks (field supply) and solar kits (field supply).
- A wired user interface is supplied with the unit to control the installation.
- The unit is delivered with an integrated backup heater for additional heating capacity during cold outdoor temperatures. The backup heater also serves as a backup in case of malfunctioning and for freeze protection of the outside water piping during winter time. The capacity of backup heater for different units is listed below.

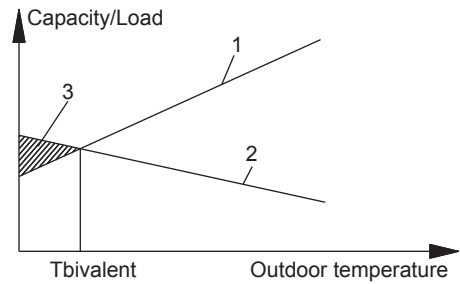

1. Heat pump capacity
2. Required heating capacity (site dependent)
3. Additional heating capacity provided by backup heater

Unit	1-phase						3-phase			
	5	7	9	10	12	14	16	12	14	16
Capacity of backup heater	3kW (optional)*			3kW(standard) 4.5kW(optional)			4.5kW			
* The backup heater is a split part, it is an option for the main unit (5,7,9kW). If the backup heater is installed, the port (CN6) for T1 in the main control board of hydraulic should connect to the corresponding port in the backup heater box (more details please refer to 9.2.2 Function diagram of hydraulic compartment)										

- **Domestic hot water tank (field supply)**
 A domestic hot water tank can be connected to the unit(with or without booster heater is both OK) .
 The requirement of the tank is different for different unit and material of heat exchanger.

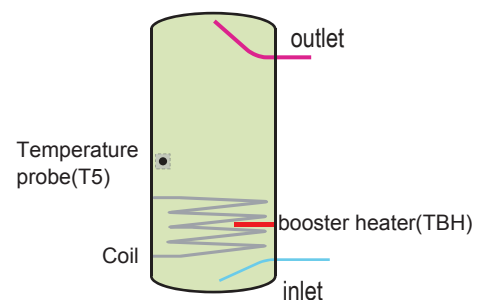

If the tank volume is greater than 240L, the temperature probe (T5) should be installed at the position which higher than half of the height of tank.
 If the tank volume is less than 240L, the temperature probe should be installed at the position which higher than 2/3 of tank's height.

The booster heater should be installed below the temperature probe. The heating exchanger (coil) should be installed below the temperature probe.
 The distance between the outdoor unit and tank should less than 5 meters.



READ THESE INSTRUCTIONS CAREFULLY BEFORE INSTALLATION. KEEP THIS MANUAL IN A HANDY PLACE FOR FUTURE REFERENCE.

IMPROPER INSTALLATION OR ATTACHMENT OF EQUIPMENT OR ACCESSORIES COULD RESULT IN ELECTRIC SHOCKS, SHORT-CIRCUITS, LEAKS, FIRE OR OTHER DAMAGE TO THE EQUIPMENT. BE SURE TO ONLY USE ACCESSORIES MADE BY THE SUPPLIER WHICH ARE SPECIFICALLY DESIGNED FOR USE WITH THE EQUIPMENT AND HAVE INSTALLATION DONE BY A PROFESSIONAL

ALL ACTIVITIES DESCRIBED IN THIS MANUAL SHALL BE CARRIED OUT BY A LICENSED TECHNICIAN.

BE SURE TO WEAR ADEQUATE PERSONAL PROTECTION SUCH AS GLOVES AND SAFETY GLASSES WHEN PERFORMING INSTALLATION, MAINTENANCE OR SERVICE TO THE UNIT.

IF UNSURE OF INSTALLATION PROCEDURES OR USE, CONTACT YOUR DEALER FOR GUIDANCE

Unit		5~9kW	10~16kW	
Volume of tank/L		minimum	100	200
		suggestion	200	300
Heating exchanger (Stainless steel coil)	heat exchange area/m ²	minimum	1.4	1.75
		suggestion	2.5	4
	Volume/L	minimum	12	14
		suggestion	20	32
Heating exchanger (Enamel coil)	heat exchange area/m ²	minimum	1.7	2.5
		suggestion	3	5.6
	Volume/L	minimum	14	20
		suggestion	24	45

■ **Room thermostat (field supply)**

Room thermostat can be connected to the unit(room thermostat should be kept away from heating source when selecting the installation place).

■ **Solar kit for domestic hot water tank (field supply)**

An optional solar kit can be connected to the unit.

■ **Remote alarm kit (field supply)**

A remote alarm kit can be connect to the unit.

■ **Operation range**

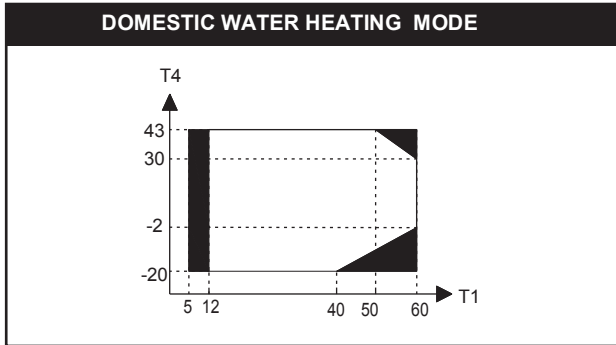
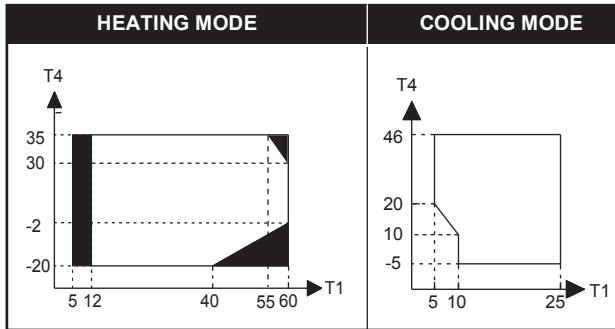

T4 Outdoor temperature(°C)

T1 Leaving water flow temperature(°C)

■ **No heat pump operation, backup heater or boiler only.**

(*) The models have a freeze prevention function that uses the heat pump and back up heater to keep the water system safe from freezing in all conditions. If there is an accidental or intentional power shutdown, using glycol is recommended (Refer to **9.3 Water pipework Caution: "Use of glycol"**).

In cooling mode, The minimum leaving water flow temperature(T1stopc) that the unit can reach in different outdoor temperature(T4) is listed below:

T4	≤10	11	12	13
T1stopc	10	9	9	8
T4	14	15	16	17
T1stopc	8	7	7	6
T4	18	19	≥20	
T1stopc	6	6	5	

In heating mode, the maximum leaving water flow temperature (T1stoph) that heat pump can reach in different outdoor temperature (T4) is listed below:

T4	-20	-19	-18	-17
T1stoph	40	41	41	42
T4	-16	-15	-14	-13
T1stoph	43	44	45	46
T4	-12	-11	-10	-9
T1stoph	47	48	49	51
T4	-8	-7	-6	-5
T1stoph	53	55	55	55
T4	-4	-3	-2	-1~29
T1stoph	56	58	60	60
T4	30	31	32	33
T1stoph	60	59	58	57
T4	34	35	36	37
T1stoph	56	55	55	55
T4	38	39	40	41
T1stoph	55	54	53	52
T4	42	43		
T1stoph	51	50		

In DHW mode, the maximum domestic hot water temperature(T5stop) that heat pump can reach in different ambient temperature(T4) is listed below:











T4		-20~-16	-15~-11	-10~-4	-5~-1
T5stop	5~9kW	45	48	50	52
	10~16kW	40	45	48	50
T4		0~4	5~9	10~14	15~19
T5stop	5~9kW	55	55	55	55
	10~16kW	53	55	55	53
T4		20~24	25~29	30~34	35~39
T5stop	5~9kW	52	50	50	48
	10~16kW	50	50	48	48
T4		40~43			
T5stop	5~9kW	45			
	10~16kW	45			

1.2 Scope of this manual

This installation & owner's manual describes the procedures for installing and connecting all monobloc outdoor unit models.



2 ACCESSORIES

2.1 Accessories supplied with the unit

INSTALLATION FITTINGS	NAME	SHAPE	QUANTITY	
			5~9kW	10~16kW
			Outdoor unit installation & owner's manual(this book)	
Wire control owner's manual		1	1	
Y-shape filter		1	1	
Water outlet connection pipe assembly		2	1	
User interface kit(digital remote controller)		1	1	
Tighten belt for customer wiring use		0	2	
		3	3	
Thermistor for domestic hot water tank or additional heating source*		1	1	
Thermistor for backup heater T1		1	0	
Transit line		1	1	

* The thermistor can be used to detect temperature of water, if domestic hot water tank installed only, the thermistor can work as T5, if boiler installed only, the thermistor can work as T1B, if both unit is installed, an additional thermistor is needed(please contact the supplier). The thermistor should connect to the corresponding port in the main control board of hydraulic.(refer to **9.2.3 Main control board of hydraulic module**).

2.2 Accessories available from supplier

NAME	SHAPE
water temperature thermistor	
Transit line(for T1B)	

3 SAFETY CONSIDERATIONS

The precautions listed here are divided into the following types. They are quite important, so be sure to follow them carefully.

Meanings of **DANGER**, **WARNING**, **CAUTION** and **NOTE** symbols.



DANGER

Indicates an imminently hazardous situation which if not avoided, will result in death or serious injury.



WARNING

Indicates a potentially hazardous situation which if not avoided, could result in death or serious injury.



CAUTION

Indicates a potentially hazardous situation which, if not avoided, may result in minor or moderate injury. It is also used to alert against unsafe practices.



NOTE

Indicates situations that could only result in accidental equipment or property damage.



DANGER

- Before touching electric terminal parts, turn off power switch.
- When service panels are removed, live parts can be easily touched by accident. Never leave the unit unattended during installation or servicing when the service panel is removed.
- Do not touch water pipes during and immediately after operation as the pipes may be hot and could burn your hand. To avoid injury, give the piping time to return to normal temperature or be sure to wear protective gloves.
- Do not touch any switch with wet fingers. Touching a switch with wet fingers can cause electrical shock.
- Before touching electrical parts, turn off all applicable power to the unit.



WARNING

- Tear apart and throw away plastic packaging bags so that children will not play with them. Children playing with plastic bags face danger of death by suffocation.
- Safely dispose of packing materials such as nails and other metal or wood parts that could cause injuries.
- Ask your dealer or qualified personnel to perform installation work in accordance with this manual. Do not install the unit yourself. Improper installation could result in water leakage, electric shocks or fire.
- Be sure to use only specified accessories and parts for installation work. Failure to use specified parts may result in water leakage, electric shocks, fire, or the unit falling from its mount.
- Install the unit on a foundation that can withstand its weight.
- Insufficient physical strength may cause the equipment to fall and possible injury.
- Perform specified installation work with full consideration of strong wind, hurricanes, or earthquakes. Improper installation work may result in accidents due to equipment falling.
- Make certain that all electrical work is carried out by qualified personnel according to the local laws and regulations and this manual using a separate circuit. Insufficient capacity of the power supply circuit or improper electrical construction may lead to electric shocks or fire.

- Be sure to install a ground fault circuit interrupter according to local laws and regulations.
Failure to install a ground fault circuit interrupter may cause electric shocks and fire.
- Make sure all wiring is secure. Use the specified wires and ensure that terminal connections or wires are protected from water and other adverse external forces.
Incomplete connection or affixing may cause a fire.
- When wiring the power supply, form the wires so that the front panel can be securely fastened.
If the front panel is not in place there could be overheating of the terminals, electric shocks or fire.
- After completing the installation work, check to make sure that there is no refrigerant leakage.
- Never directly touch any leaking refrigerant as it could cause severe frostbite.
- Do not touch the refrigerant pipes during and immediately after operation as the refrigerant pipes may be hot or cold, depending on the condition of the refrigerant flowing through the refrigerant piping, compressor and other refrigerant cycle parts. Burns or frostbite are possible if you touch the refrigerant pipes. To avoid injury, give the pipes time to return to normal temperature or, if you must touch them be sure to wear protective gloves.
- Do not touch the internal parts (pump, backup heater, etc.) during and immediately after operation.
Touching the internal parts can cause burns. To avoid injury, give the internal parts time to return to normal temperature or, if you must touch them, be sure to wear protective gloves.



CAUTION

- Ground the unit.
Grounding resistance should be according to local laws and regulations
Do not connect the ground wire to gas or water pipes, lightning conductors or telephone ground wires.
Incomplete grounding may cause electric shocks. 
 - a) Gas pipes.
Fire or an explosion might occur if the gas leaks.
 - b) Water pipes.
Hard vinyl tubes are not effective grounds.
 - c) Lightning conductors or telephone ground wires.
Electrical threshold may rise abnormally if struck by a lightning bolt.
- Install the power wire at least 3 feet (1 meter) away from televisions or radios to prevent interference or noise. (Depending on the radio waves, a distance of 3 feet (1 meter) may not be sufficient to eliminate the noise.)
- Do not wash the unit. This may cause electric shocks or fire. The appliance must be installed in accordance with national wiring regulations. If the supply cord is damaged, it must be replaced by the manufacturer, its service agent or similarly qualified persons in order to avoid a hazard.
- Do not install the unit in the following places:
 - a) Where there is mist of mineral oil, oil spray or vapors.
Plastic parts may deteriorate, and cause them to come loose or water to leak.
 - b) Where corrosive gases (such as sulphurous acid gas) are produced.
Where corrosion of copper pipes or soldered parts may cause refrigerant to leak.
 - c) Where there is machinery which emits electromagnetic waves.
Electromagnetic waves can disturb the control system and cause equipment malfunction.
 - d) Where flammable gases may leak, where carbon fiber or ignitable dust is suspended in the air or where volatile flammables such as paint thinner or gasoline are handled.
These types of gases might cause a fire.
 - e) Where the air contains high levels of salt such as near the ocean.

- f) Where voltage fluctuates a lot, such as in factories.
- g) In vehicles or vessels.
- h) Where acidic or alkaline vapors are present.

- This appliance can be used by children 8 years old and above and persons with reduced physical, sensory or mental capabilities or lack of experience and knowledge if they are supervised or given instruction on using the unit in a safe manner and understand the hazards involved. Children should not play with the unit. Cleaning and user maintenance should not be done by children without supervision.
- Children should be supervised to ensure that they do not play with the appliance.
- If the supply cord is damaged, it must be replaced by the manufacturer or its service agent or a similarly qualified person.
- DISPOSAL: Do not dispose this product as unsorted municipal waste. Collection of such waste separately for special treatment is necessary.
Do not dispose of electrical appliances as municipal waste, use separate collection facilities.
Contact your local government for information regarding the collection systems available.
If electrical appliances are disposed of in landfills or dumps, hazardous substance can leak into the groundwater and get into the food chain, damaging your health and well-being.
- The wiring must be performed by professional technicians in accordance with national wiring regulation and this circuit diagram. An all-pole disconnection device which has at least 3mm separation distance in all pole and a residual current device (RCD) with the rating not exceeding 30mA shall be incorporated in the fixed wiring according to the national rule.

4 BEFORE INSTALLATION

Before installation

Be sure to confirm the model name and the serial number of the unit.

Handling

Due to relatively large dimensions and heavy weight, the unit should only be handled using lifting tools with slings. The slings can be fitted into foreseen sleeves at the base frame that are made specifically for this purpose



CAUTION

- To avoid injury, do not touch the air inlet or aluminum fins of the unit.
- Do not use the grips in the fan grills to avoid damage.
- The unit is top heavy! Prevent the unit from falling due to improper inclination during handling.

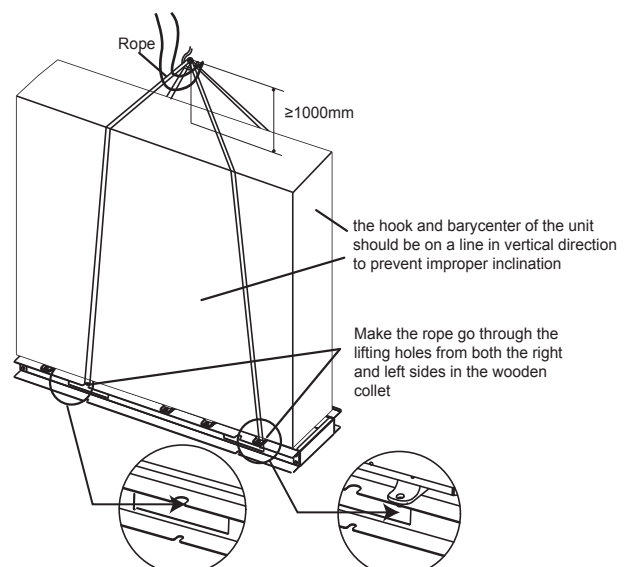

The position of barycenter for different unit can be seen in the picture below.

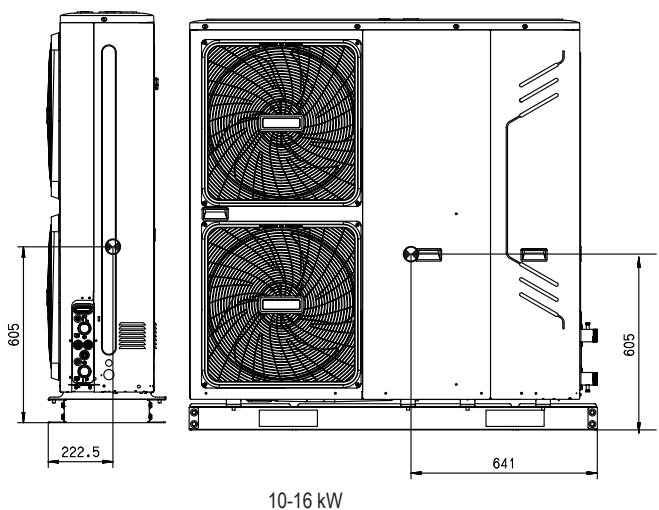
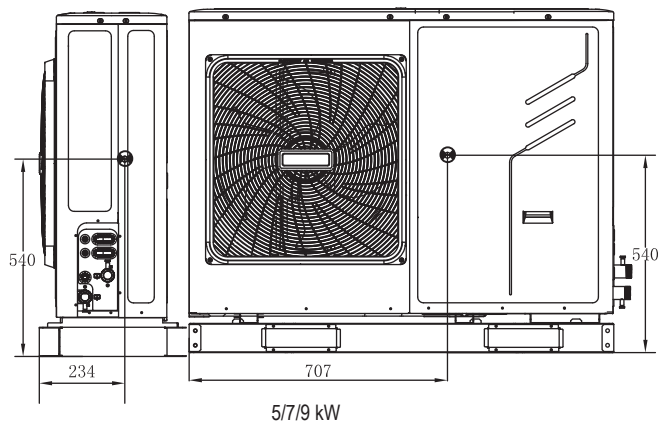

5 IMPORTANT INFORMATION REGARDING THE REFRIGERANT USED

This product contains fluorinated greenhouse gases covered by the Kyoto Protocol. Do not vent gases into the atmosphere.

Refrigerant type: R410A

GWP⁽¹⁾ value: 2088

(1) GWP = global warming potential

The refrigerant quantity is indicated on the unit name plate

6 SELECTING INSTALLATION SITE



WARNING

- Be sure to provide for adequate measures in order to prevent that the unit be used as a shelter by small animals.
- Small animals making contact with electrical parts can cause malfunctions, smoke or fire. Please instruct the customer to keep the area around the unit clean.

- 1 Select an installation site where the following conditions are satisfied and one that meets with your customer's approval.
 - Places that are well-ventilated.
 - Places where the unit does not disturb next-door neighbors.
 - Safe places which can bear the unit's weight and vibration and where the unit can be installed at an even level.
 - Places where there is no possibility of flammable gas or product leak.
 - The equipment is not intended for use in a potentially explosive

atmosphere.

- Places where servicing space can be well ensured.
- Places where the units' piping and wiring lengths come within the allowable ranges.
- Places where water leaking from the unit cannot cause damage to the location (e.g. in case of a blocked drain pipe).
- Places where rain can be avoided as much as possible.
- Do not install the unit in places often used as a work space.
- In case of construction work (e.g. grinding etc.) where a lot of dust is created, the unit must be covered.
- Do not place any objects or equipment on top of the unit (top plate)
- Do not climb, sit or stand on top of the unit.
- Be sure that sufficient precautions are taken in case of refrigerant leakage according to relevant local laws and regulations.
- Don't install the unit near the sea or where there is corrosion gas,

- 2 When installing the unit in a place exposed to strong wind, pay special attention to the following.

Strong winds of 5 m/sec or more blowing against the unit's air outlet causes a short circuit (suction of discharge air), and this may have the following consequences:

- Deterioration of the operational capacity.
- Frequent frost acceleration in heating operation.
- Disruption of operation due to rise of high pressure.
- When a strong wind blows continuously on the front of the unit, the fan can start rotating very fast until it breaks.

In normal condition, refer to the figures below for installation of the unit:

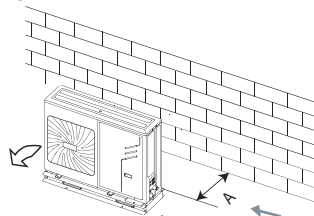

Unit	A(mm)
5-9kW	300
10-16kW	300

In case of strong wind and the wind direction can be foreseen, refer to the figures below for installation of the unit (any one is OK):

- Turn the air outlet side toward the building's wall, fence or screen.

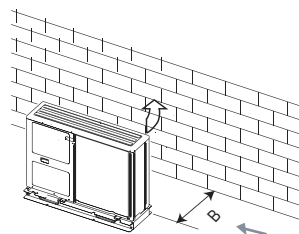

Unit	B(mm)
5-9kW	1000
10-16kW	1500

Make sure there is enough room to do the installation

- Set the outlet side at a right angle to the direction of the wind.

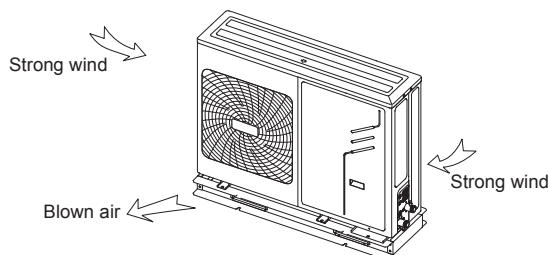

- 3 Prepare a water drainage channel around the foundation, to drain waste water from around the unit.
- 4 If water does not easily drain from the unit, mount the unit on a foundation of concrete blocks, etc. (the height of the foundation should be about 100 mm (3.93 in)).
- 5 If you install the unit on a frame, please install a waterproof plate (about 100 mm) on the underside of the unit to prevent water from coming in from the low side.
- 6 When installing the unit in a place frequently exposed to snow, pay special attention to elevate the foundation as high as possible.

7 If you install the unit on a building frame, please install a waterproof plate (field supply) (about 100 mm, on the underside of the unit) in order to avoid drain water dripping. (See the picture in the right).

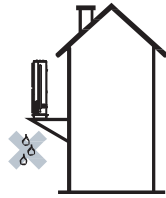

NOTE

Unit is top heavy!
Try not to install on the building frame.

6.1 Selecting a location in cold climates

Refer to "Handling" in section "4 Before installation"



NOTE

When operating the unit in cold climates, be sure to follow the instructions described below.

- To prevent exposure to wind, install the unit with its suction side facing the wall.
- Never install the unit at a site where the suction side may be exposed directly to wind.
- To prevent exposure to wind, install a baffle plate on the air discharge side of the unit.
- In heavy snowfall areas it is very important to select an installation site where the snow will not affect the unit. If lateral snowfall is possible, make sure that the heat exchanger coil is not affected by the snow (if necessary construct a lateral canopy).

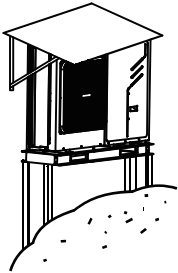

- 1 Construct a large canopy.
- 2 Construct a pedestal.
Install the unit high enough off the ground to prevent it from being buried in snow.

6.2 Selecting a location in hot climates

As the outdoor temperature is measured via the outdoor unit air thermistor, make sure to install the outdoor unit in the shade, or a canopy should be constructed to avoid direct sunlight, so that it is not influenced by the sun's heat, otherwise protection may be possible to the unit.

7 PRECAUTIONS ON INSTALLATION

- Check the strength and level of the installation ground so that the unit will not cause any operating vibration or noise after installation.
- In accordance with the foundation drawing in the figure, fix the unit securely by means of the foundation bolts. (Prepare four sets each of $\Phi 10$ Expansion bolts, nuts and washers which are readily available on the market.)
- It is best to screw in the foundation bolts until their length is 20 mm from the foundation surface.

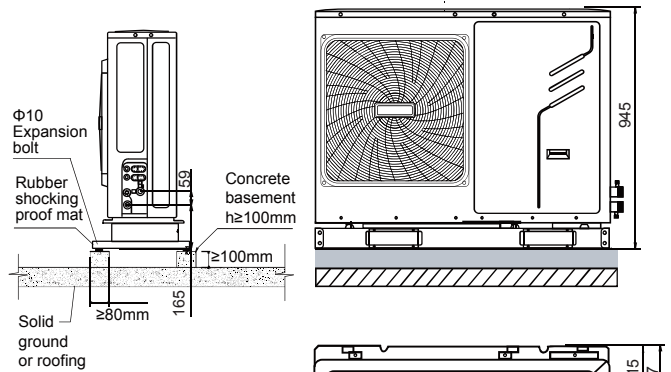
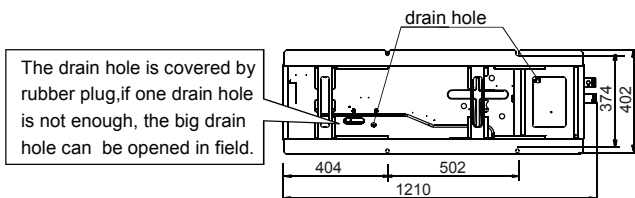

5/7/9 kW (unit: mm)

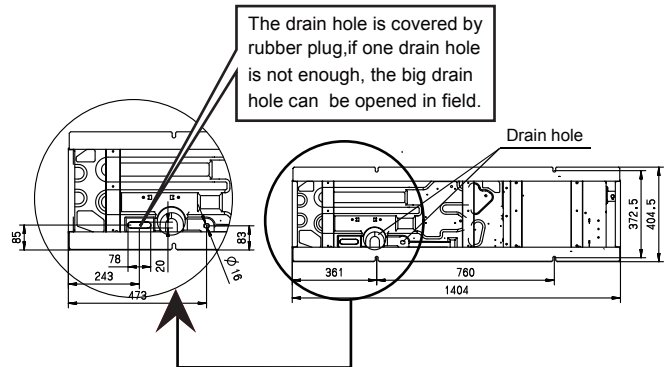

Note: if water can't drain out in cold winter even the big drain hole has opened, an electrical heating tap is necessary, which is available from the supplier.

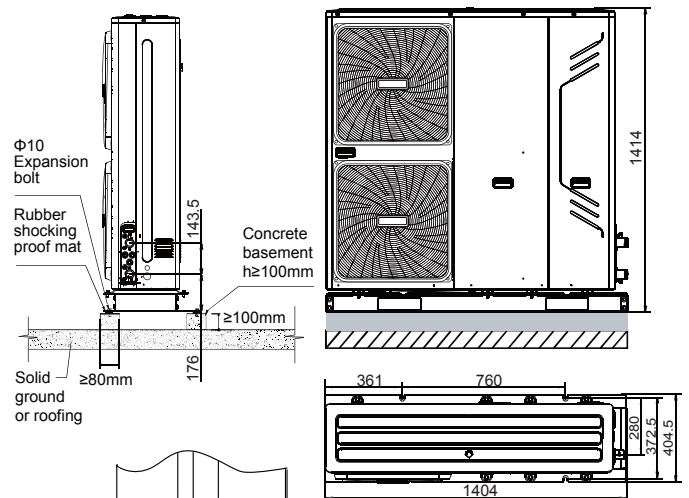

10/12/14/16 kW (unit: mm)



NOTE

If drain holes in the unit are covered by a mounting base or by floor surface, raise the unit in order to provide a free space of more than 100 mm under the unit.

7.1 Installation servicing space

(A) In case of stacked installation

1. In case obstacles exist in front of the outlet side.

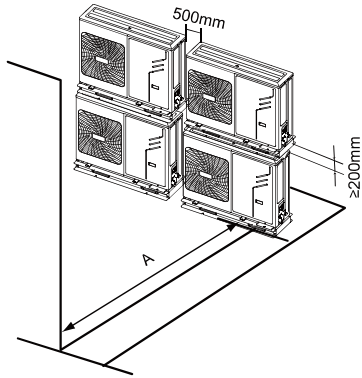

Unit	A(mm)
5-9kW	1000
10-16kW	1500

2. In case obstacles exist in front of the air inlet.

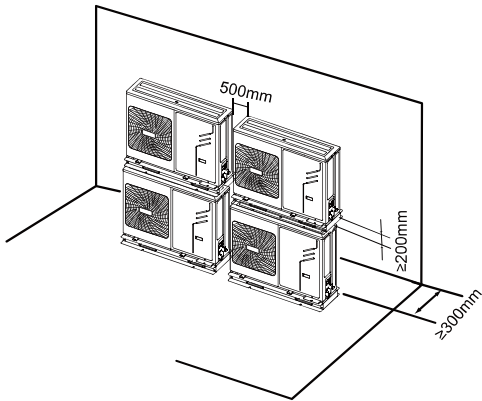

(B) In case of multiple-row installation (for roof top use, etc.)

1. In case of installing one unit per row.

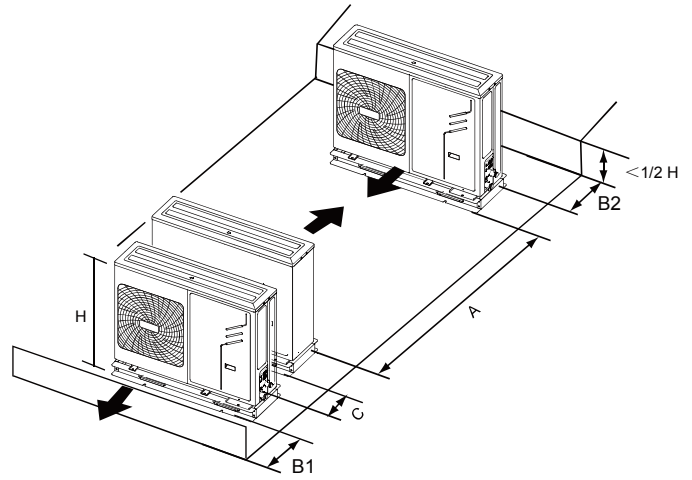

Unit	A(mm)	B1(mm)	B2(mm)	C(mm)
5-9kW	1500	500	150	300
10-16kW	2000	1000	150	300

2. In case of installing multiple units (2 units or more) in lateral connection per row.

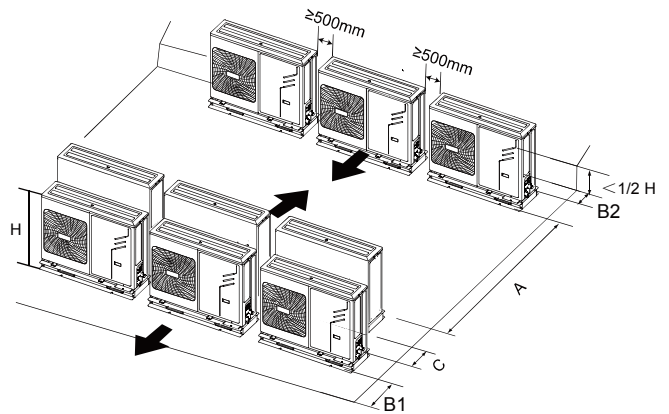

Unit	A(mm)	B1(mm)	B2(mm)	C(mm)
5-9kW	2000	500	300	300
10-16kW	2500	1000	300	300

8 TYPICAL APPLICATION EXAMPLES

The application examples given below are for illustration purposes only.

8.1 Application 1

Space heating only application with a room thermostat connected to the unit.

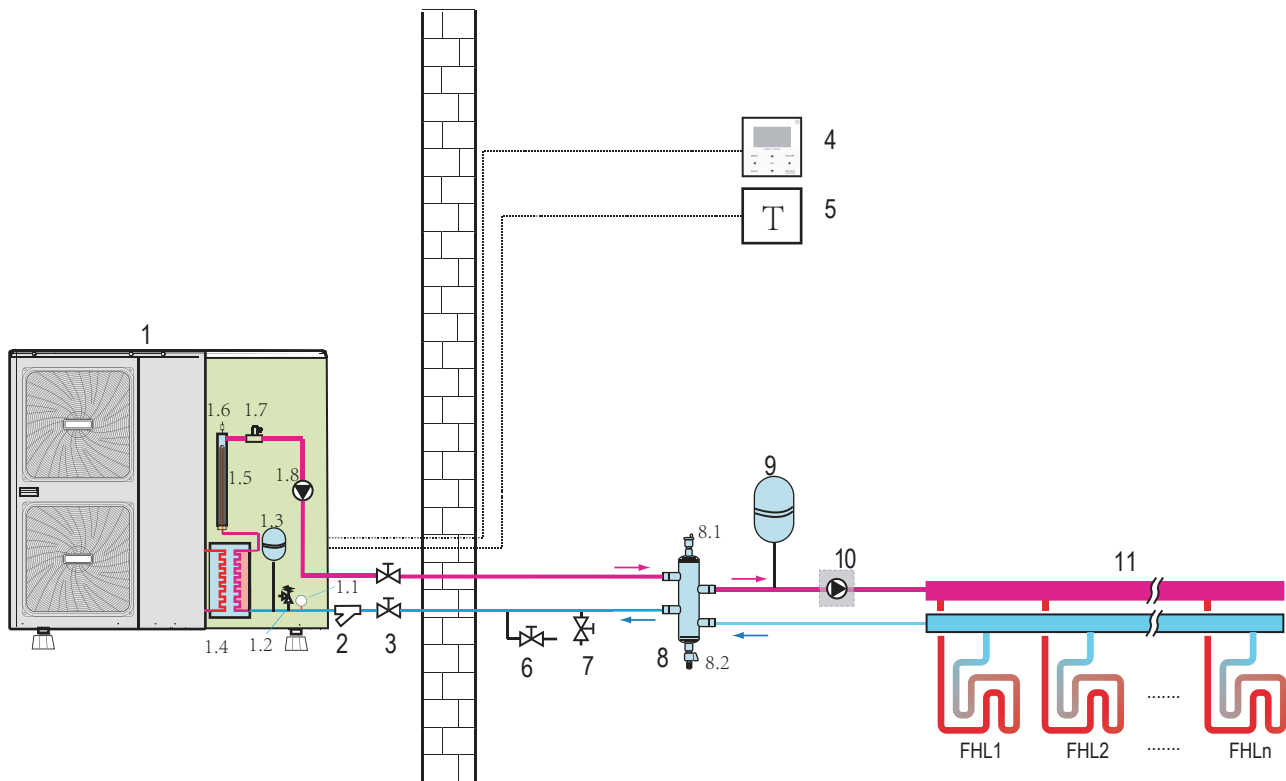

- | | |
|----------------------------------|-------------------------------------------------|
| 1 outdoor unit | 5 room thermostat (field supply) |
| 1.1 manometer | 6 drain valve (field supply) |
| 1.2 pressure relief valve | 7 fill valve (field supply) |
| 1.3 expansion vessel | 8 balance tank (field supply) |
| 1.4 plate heat exchanger | 8.1 air purge valve |
| 1.5 backup heater | 8.2 drain valve |
| 1.6 air purge valve | 9 expansion vessel (field supply) |
| 1.7 flow switch | 10 P_o: Outside circulation pump (field supply) |
| 1.8 P_i: Inside circulation pump | 11 collector (field supply) |
| 2 y-shape filter | FHL 1...n floor heating loop |
| 3 stop valve (field supply) | |
| 4 user interface | |



NOTE

The volume of balance tank(8) should be greater than 40L(for 5~9kW unit, greater than 20L). The drain valve (6) should be installed at the lowest position of the system. For 5/7/9kW unit, the backup heater (1.5) is not integrated in the outdoor unit. An independent backup heater can be selected and installed in the door. pump(10) should be controlled by outdoor unit and connect to corresponding port in the outdoor unit(refer to **9.6.6 Connection for other components/For outside circulation pump P_o**).

Unit operation and space heating

When a room thermostat is connected to the unit and when there is a heating request from the room thermostat, the unit will start operating to achieve the target water flow temperature as set on the user interface. When the room temperature is above the thermostat set point in the heating mode, the unit will stop operating. The circulation pump (1.8) and (10) will also stop running. The room thermostat is used as a switch here.



NOTE

Make sure to connect the thermostat wires to the correct terminals, method B should be selected (see **"For room thermostat"** in **9.6.6 connection for other components**). To correctly configure the ROOM THERMOSTAT in the **FOR SERVICEMAN** mode see **10.7 Field settings/ROOM THERMOSTAT**.

8.2 Application 2

Space heating only application without room thermostat connected to the unit. Domestic hot water is provided through the domestic hot water tank that is connected to the unit.

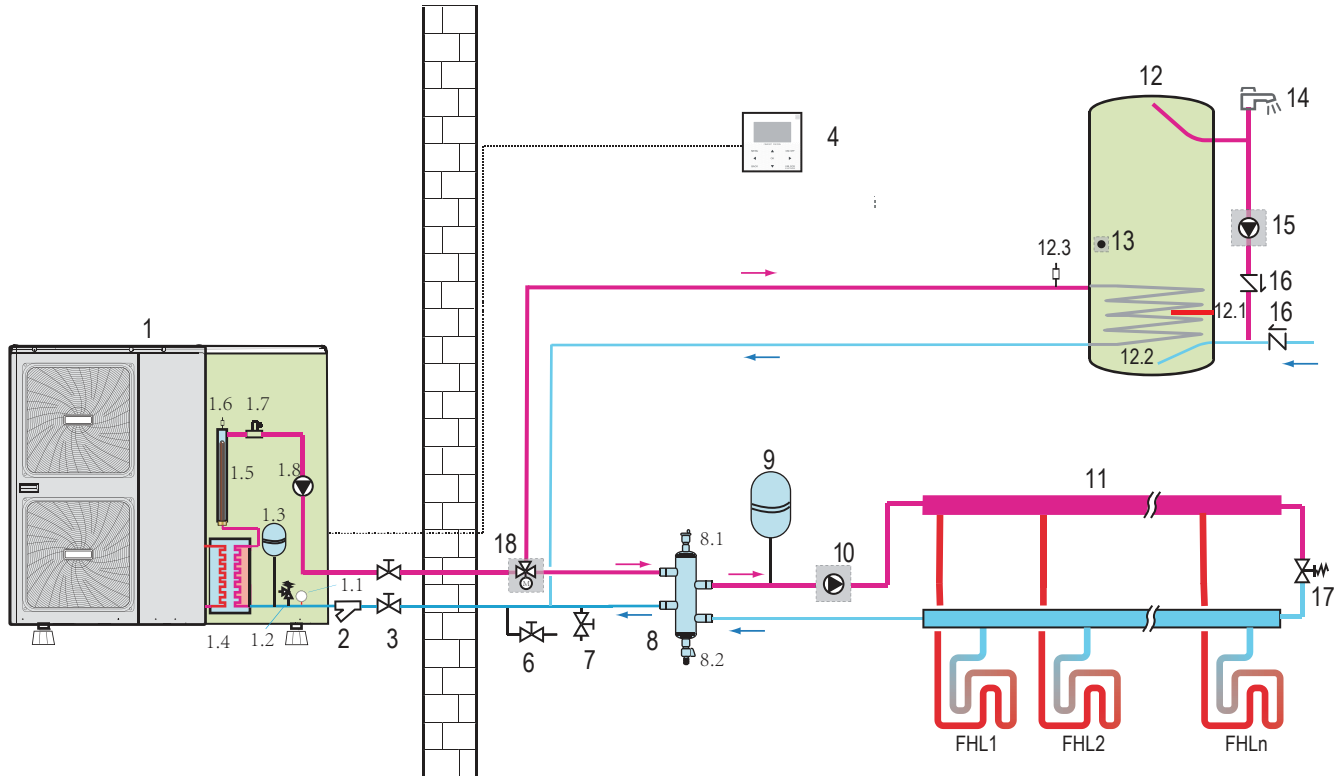

- | | | |
|-------------------------------------------|-------------------------------------------------|------------------------------------|
| 1 outdoor unit | 4 user interface | 12.1 booster heater |
| 1.1 manometer | 6 drain valve (field supply) | 12.2 heat exchanger coil |
| 1.2 pressure relief valve | 7 fill valve (field supply) | 12.3 air purge valve |
| 1.3 expansion vessel | 8 balance tank (field supply) | 13 T5: temperature sensor |
| 1.4 plate heat exchanger | 8.1 air purge valve | 14 hot water tap (field supply) |
| 1.5 backup heater | 8.2 drain valve | 15 P_d: DHW pump (field supply) |
| 1.6 air purge valve | 9 expansion vessel (field supply) | 16 non-return valve (field supply) |
| 1.7 flow switch | 10 P_o: outside circulation pump (field supply) | 17 bypass valve (field supply) |
| 1.8 P_i: circulation pump inside the unit | 11 collector (field supply) | 18 SV1: 3-way valve (field supply) |
| 2 y-shape filter | 12 domestic hot water tank (field supply) | FHL 1...n floor heating loop |
| 3 stop valve (field supply) | | |



NOTE

The volume of balance tank(8) should be greater than 40L(for 5~9kW unit, greater than 20L) The drain valve (6) should be installed at the lowest position of the system. For 5/7/9kW unit, the backup heater (1.5) is not integrated in the outdoor unit. An independent backup heater can be selected and installed in the door. pump(10) should be controlled by outdoor unit and connect to corresponding port in the outdoor unit(refer to **9.6.6 Connection for other components/For outside circulation pump P_o**).

■ Circulation pump operation

The circulation pump (1.8) and (11) will operate as long as the unit is on for space heating.
The circulation pump (1.8) will operate as long as the unit is on for heating domestic hot water (DHW).

■ Space heating

- 1) The unit (1) will operate to achieve the target water flow temperature set on the user interface.
- 2) The bypass valve should be selected so that at all times the minimum water flow as mentioned in **9.3 Water pipework** is guaranteed.

■ Domestic water heating

- 1) When the domestic water heating mode is enabled (either manually by the user, or automatically through scheduling) the target domestic hot water temperature will be achieved by a combination of the heat exchanger coil and the electrical booster heater (when the booster heater in the tank is set to YES).
- 2) When the domestic hot water temperature is below the user configured set point, the 3-way valve will be activated to heat the domestic water by means of the heat pump. If there is a huge demand for hot water or a high hot water temperature setting, the booster heater (12.1) can provide auxiliary heating.



CAUTION

Make sure to fit the 3-way valve correctly. For more details, refer to **9.6.6 Connection for other components/For 3-way valve SV1**.



NOTE

The unit can be configured so that at low outdoor temperatures, water is exclusively heated by the booster heater. This assures that the full capacity of the heat pump is available for space heating.

Details on domestic hot water tank configuration for low outdoor temperatures (T4DHWMIN) can be found in **10.7 Field settings/How to set the DHW MODE**.

8.3 Application 3

Space cooling and heating application with a **room thermostat suitable for heating/cooling changeover** when connected to the unit. Heating is provided through floor heating loops and fan coil units. Cooling is provided through the fan coil units only. Domestic hot water is provided through the domestic hot water tank which is connected to the unit.

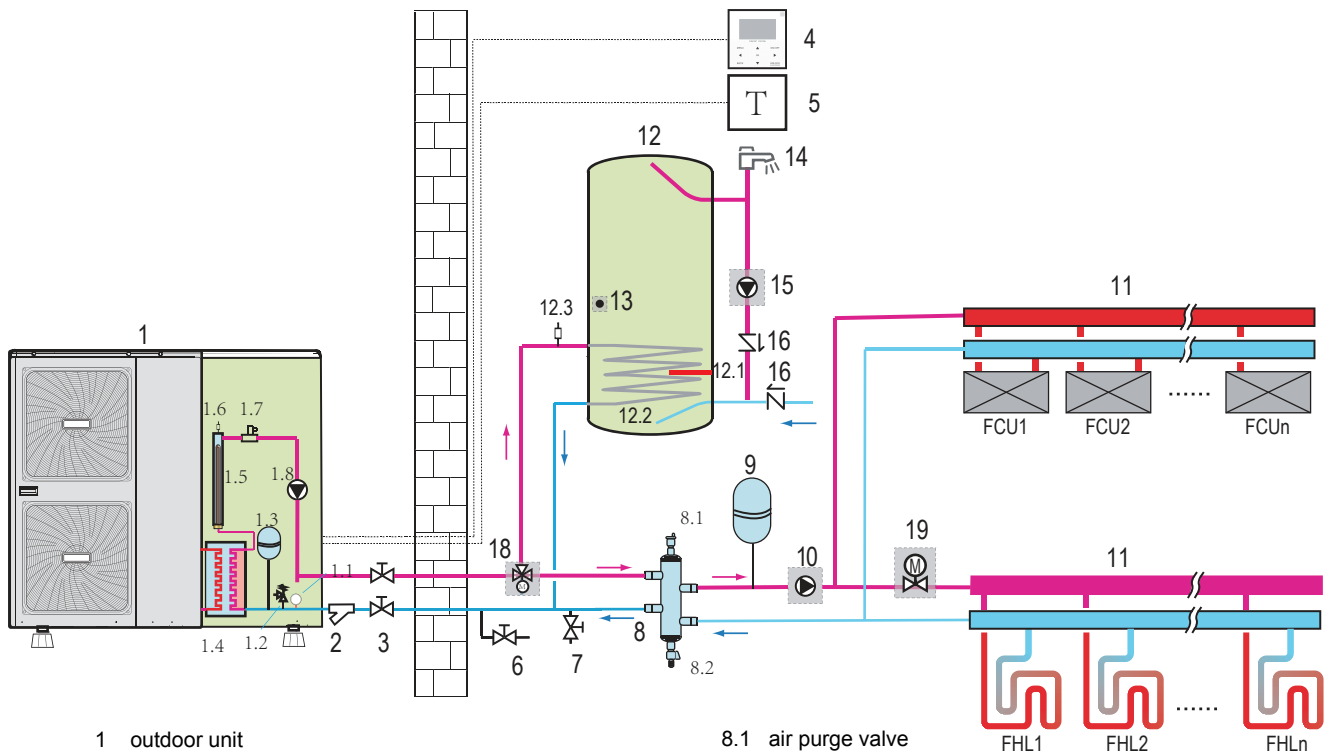

- 1 outdoor unit
- 1.1 manometer
- 1.2 pressure relief valve
- 1.3 expansion vessel
- 1.4 plate heat exchanger
- 1.5 backup heater
- 1.6 air purge valve
- 1.7 flow switch
- 1.8 P_i: circulation pump inside the unit
- 2 y-shape filter
- 3 stop valve (field supply)
- 4 user interface
- 5 room thermostat (field supply)
- 6 drain valve (field supply)
- 7 fill valve (field supply)
- 8 balance tank (field supply)

- 8.1 air purge valve
- 8.2 drain valve
- 9 expansion vessel (field supply)
- 10 P_o: outside circulate pump (field supply)
- 11 collector (field supply)
- 12 domestic hot water tank (field supply)
- 12.1 booster heater
- 12.2 heat exchanger coil
- 12.3 air purge valve
- 13 T5: temperature sensor
- 14 hot water tap (field supply)
- 15 P_d: DWH pipe pump (field supply)
- 16 non-return valve (field supply)
- 18 SV1: 3-way valve (field supply)
- 19 SV2: 2-way valve (field supply)
- FHL 1...n floor heating loop
- FCU 1...n fan coil units



NOTE

The volume of balance tank(8) should be greater than 40L(for 5~9kW unit, greater than 20L) The drain valve (6) should be installed at the lowest position of the system. For 5/7/9kW unit, the backup heater (1.5) is not integrated in the outdoor unit. An independent backup heater can be selected and installed in the door.pump(10) should be controlled by outdoor unit and connect to corresponding port in the outdoor unit(refer to **9.6.6 Connection for other components/For outside circulation pump P_o**).

■ Pump operation and space heating and cooling

The unit will switch to either heating or cooling mode according to the setting of room thermostat.

When space heating/cooling is requested by the room thermostat (5), the pump will start operating and the unit (1) will switch to heating mode/cooling mode. The unit (1) will operating to achieve the target cold/hot water leaving temperature.

In the cooling mode. the motorized 2-way valve (19) will close to prevent cold water running through the floor heating loops (FHL).

CAUTION

- Make sure to connect the thermostat wires to the correct terminals and to configure the ROOM THERMOSTAT in the user interface correctly (see **10.7 Field settings/ROOM THERMOSTAT**). Wiring of the room thermostat should follow **method A** as described in **9.6.6 connection for other components/For room thermostat**.
- Wiring of the 2-way valve (19) is different for a NC (normal closed) valve and a NO (normal open) valve! Make sure to connect to the correct terminal numbers as detailed on the wiring diagram.

The ON/OFF setting of the heating/cooling operation cannot be done on the user interface, the target outlet water temperature should be set in the user interface.

■ Domestic water heating

Domestic water heating is as described in **8.2 Application 2**.

8.4 Application 4

Space cooling and heating application without a room thermostat connected to the unit, the temperature sensor **T_a** attached in the user interface is used to control the ON/OFF of the unit. Heating is provided through floor heating loops and fan coil units. Cooling is provided through fan coil units only.

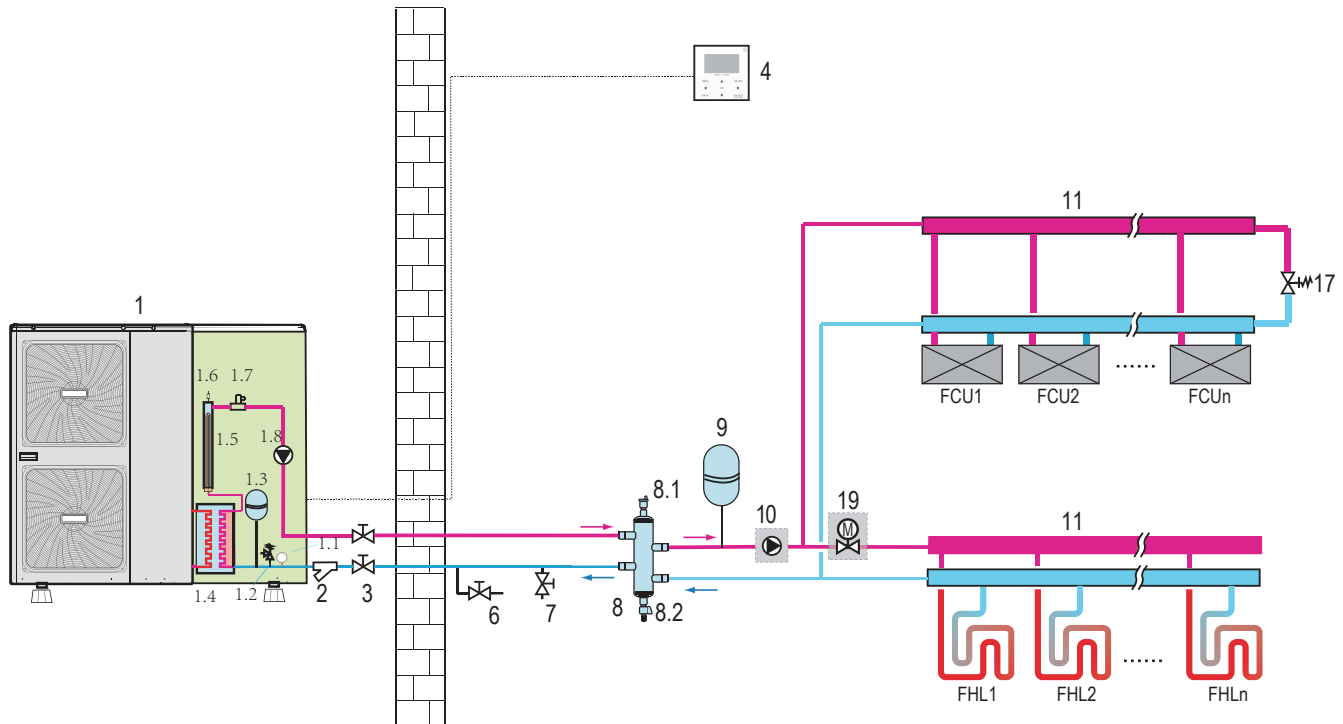

- | | | |
|---------------------------------------------------|-----------------------------------------------------------|------------------------------------|
| 1 outdoor unit | 3 stop valve (field supply) | 11 collector (field supply) |
| 1.1 manometer | 4 user interface | 17 bypass valve (field supply) |
| 1.2 pressure relief valve | 6 drain valve (field supply) | 19 SV2: 2-way valve (field supply) |
| 1.3 expansion vessel | 7 fill valve (field supply) | FHL 1...n floor heating loop |
| 1.4 plate heat exchanger | 8 balance tank (field supply) | FCU 1...n fan coil units |
| 1.5 backup heater | 8.1 air purge valve | |
| 1.6 air purge valve | 8.2 drain valve | |
| 1.7 flow switch | 9 expansion vessel (field supply) | |
| 1.8 P _i : circulation pump in the unit | 10 P _o : outside circulate pump (field supply) | |
| 2 y-shape filter | | |



NOTE

The volume of balance tank(8) should be greater than 40L(for 5~9kW unit, greater than 20L) The drain valve (6) should be installed at the lowest position of the system. For 5/7/9kW unit, the backup heater (1.5) is not integrated in the outdoor unit. An independent backup heater can be selected and installed in the door. pump(10) should be controlled by outdoor unit and connect to corresponding port in the outdoor unit(refer to **9.6.6 Connection for other components/For outside circulation pump P_o**).

Pump operation

The circulation pump (1.8) and (10) will operate as long as the unit is on for space heating.

NOTE

As the temperature sensor is used to detect the room temperature, the user interface (4) should be placed in the room where floor heating loops and fan coil units is installed and away from the heating source. Correct configuration should be applied in the user interface (refer to **10.7 field settings/TEMP. TYPE SETTING**). The target room temperature can be set on the main page of user interface, the target outlet water temperature will be calculated from climate related curves, the unit will turn off when the room temperature reaches the target temperature.

Space heating and cooling

According to the season, the customer selects cooling or heating through the user interface. The unit (1) will operate in cooling mode or heating mode to achieve the target room temperature. In heating mode, the 2-way valve (19) will open. Hot water is provided to both the fan coil units and the floor heating loops. In cooling mode, the motorized 2-way valve (19) is closed to prevent cold water running through the floor heating loops (FHL).



CAUTION

Wiring of the 2-way valve (19) is different for a NC (normal closed) valve and a NO (normal open) valve. The NO valve is unavailable to this unit. Make sure to connect to the correct terminal numbers as detailed on the wiring diagram.

The ON/OFF setting of the heating/cooling operation is done by the user interface.

8.5 Application 5

Space heating with an auxiliary boiler (alternating operation).

Space heating application by either the unit or by an auxiliary boiler connected in the system.

- The unit controlled contact (also called 'permission signal for the auxiliary boiler") is determined by the outdoor temperature (thermistor located at the outdoor unit). See **10.7 Field settings/OTHER HEATING SOURCE**
 - Bivalent operation is possible for both space heating operation and domestic water heating operation.
 - If the auxiliary boiler only provides heat for space heating, the boiler must be integrated in the piping work and in the field wiring according to the illustration for **application a**.
 - If the auxiliary boiler is also providing heat for domestic hot water, the boiler can be integrated in the piping work and in the field wiring according to the illustration for **application b**. In this condition, the unit can sent ON/OFF signal to boiler in heating mode, but the boiler control itself in DHW mode.
 - If the auxiliary boiler only provides heat for domestic water heating, the boiler must be integrated in the piping work and in the field wiring according to the illustration for **application c**.
-



CAUTION

Be sure that the boiler and the integration of the boiler in the system is in accordance with relevant local laws and regulations.

Application a

Boiler provide heat for space heating only

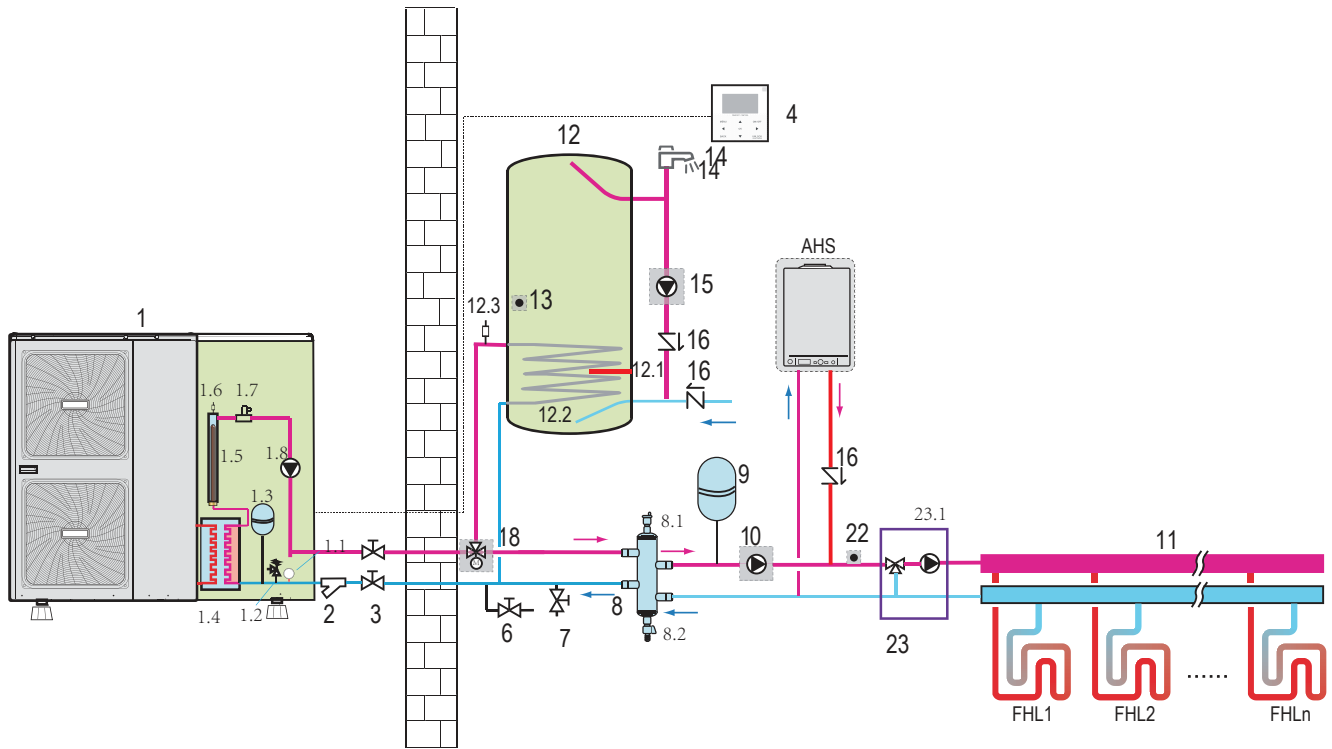

Application b

Boiler provide heat for space heating and domestic water heating, the ON/OFF of boiler is controlled by itself for domestic water heating.

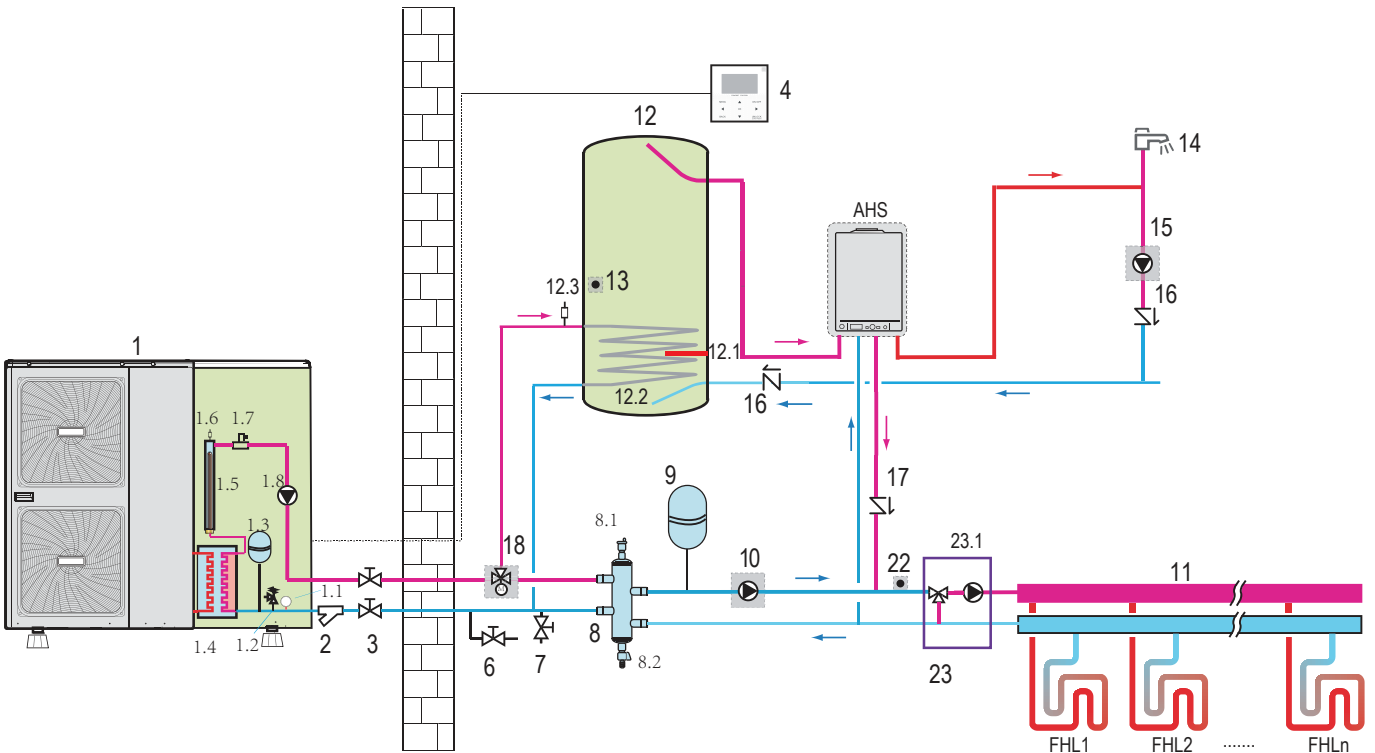

Application c

Boiler provide heat for space heating and domestic water heating. the ON/OFF of boiler controlled by unit.

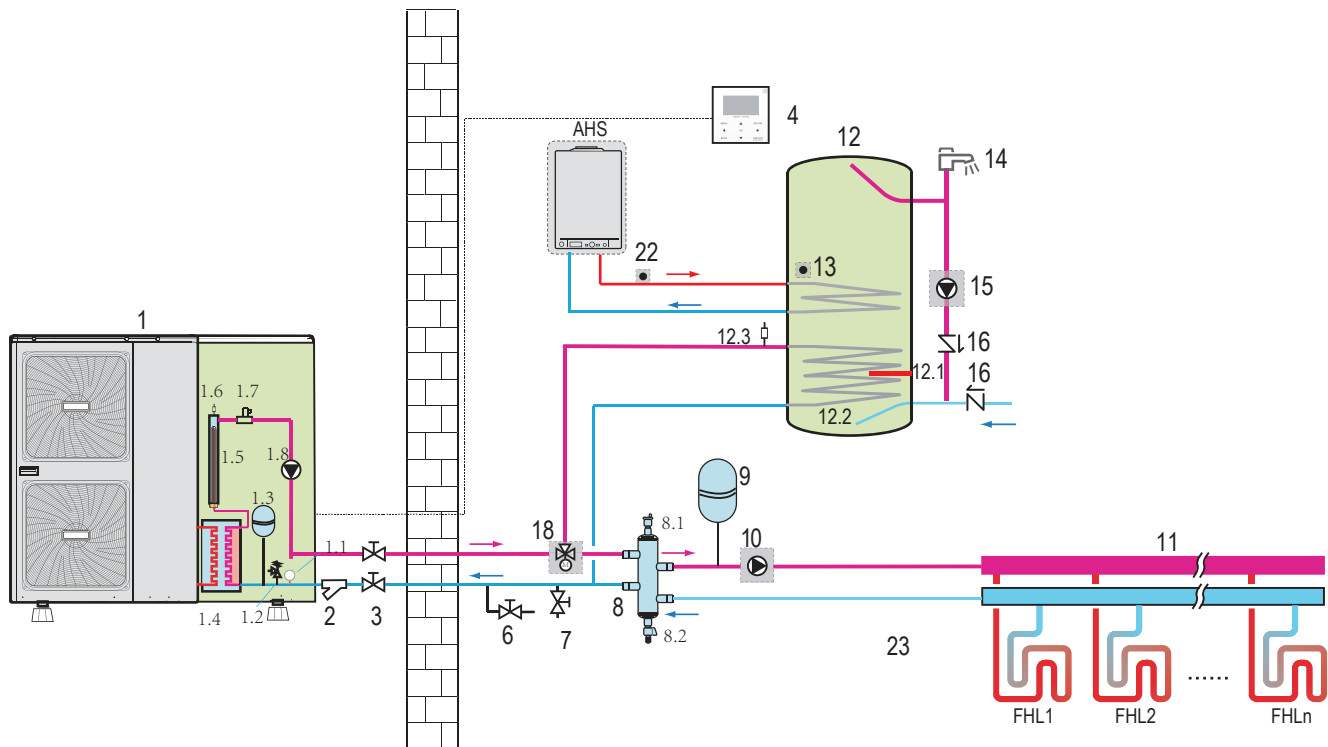

- | | | |
|-------------------------------------------|-------------------------------------------------|------------------------------------------|
| 1 outdoor unit | 8 balance tank(field supply) | 16 non-return valve(field supply) |
| 1.1 manometer | 8.1 air purge valve | 18 SV1: 3-way valve(field supply) |
| 1.2 pressure relief valve | 8.2 drain valve | 22 T1B: temperature sensor(field supply) |
| 1.3 expansion vessel | 9 expansion vessel(field supply) | 23 mixing station(field supply) |
| 1.4 plate heat exchanger | 10 P_o: outside circulation pump (field supply) | 23.1 P_c: mixing pump |
| 1.5 backup heater | 11 collector(field supply) | FHL 1...n floor heating loop |
| 1.6 air purge valve | 12 domestic hot water tank(field supply) | AHS additional heating source(boiler) |
| 1.7 flow switch | 12.1 booster heater | |
| 1.8 P_i: circulation pump inside the unit | 12.2 heat exchanger coil | |
| 2 y-shape filter | 12.3 air purge valve | |
| 3 stop valve (field supply) | 13 T5:temperature sensor | |
| 4 user interface | 14 hot water tap(field supply) | |
| 6 drain valve(field supply) | 15 P_d: DHW pump(field supply) | |
| 7 fill valve(field supply) | | |



NOTE

The volume of balance tank(8) should be greater than 40L(for 5~9kW unit, greater than 20L) The drain valve (6) should be installed at the lowest position of the system. For 5/7/9kW unit, the backup heater (1.5) is not integrated in the outdoor unit. An independent backup heater can be selected and installed in the door. Temperature sensor T1B must be installed at the outlet of AHS, and connect to the corresponding port in the main control board of hydraulic module(refer to **9.2.3 Main control board of hydraulic module**), pump(10) should be controlled by outdoor unit and connect to correspondingport in the outdoor unit(refer to **9.6.6 Connection for other components/ For outside circulation pump P_o**). .

Operation

When heating is required, either the unit or the boiler starts operating, depending on the outdoor temperature (refer to **10.7 field setting/OTHER HEATING SOURCE**).

- As the outdoor temperature is measured via the outdoor unit air thermistor, make sure to install the outdoor unit in the shade, so that it is not influenced by the sun's heat.
- Frequent switching can cause corrosion of the boiler at an early stage. Contact the boiler manufacturer.
- During heating operation of the unit, the unit will operate to achieve the target water flow temperature set on the user interface. When weather dependent operation is active, the water temperature is determined automatically depending on the outdoor temperature.

- During heating operation of the boiler, the boiler will operate to achieve the target water flow temperature set on the user interface.
- Never set the target water flow temperature set point on the user interface above (60°C).



NOTE

Make sure to correctly configure FOR SERVICEMAN in the user interface. Refer to **10.7 Field settings/Other heating source**.



CAUTION

- Ensure that return water to the heat exchanger does not exceed 60°C. Never put the target water flow temperature set point on the user interface above 60°C.
- Make sure that the non-return valves (field supply) are correctly installed in the system.
- The supplier will not be held liable for any damage resulting from failure to observe this rule.

8.6 Application 6

Dual setpoint function application with two room thermostat connect to the outdoor unit.

- Space heating with two room thermostat application through floor heating loops and fan coil units. The floor heating loops and fan coil units require different operating water temperatures.
- The floor heating loops require a lower water temperature in heating mode compared to fan coil units. To achieve these two set points, a mixing station is used to adapt the water temperature according to requirements of the floor heating loops. The fan coil units are directly connected to the unit water circuit and the floor heating loops are after the mixing station. Control of this mixing station is not done by the unit.
- The operation and configuration of the field water circuit is the responsibility of the installer.
- We only offer a dual set point control function. This function allows two set points to be generated. Depending on the required water temperature (floor heating loops and/or fan coil units are required) the first set point(set on the user interface) or second set point(calculate from climate related curves) can be activated. More details refer to **10.7 field setting /ROOM THERMOSTAT**.



NOTE

The wiring of room thermostat 5A(for fan coil units) and 5B(for floor eating loops) should follow 'method C' as described in **9.6.6 Connection for other components/For room thermostat**, and the thermostat which connect to port 'C' (in the outdoor unit) should be placed on the zone where floor heating loops is installed(zone B), the other one connect to port 'H' should be placed on the zone where fan coil units is installed(zone A).

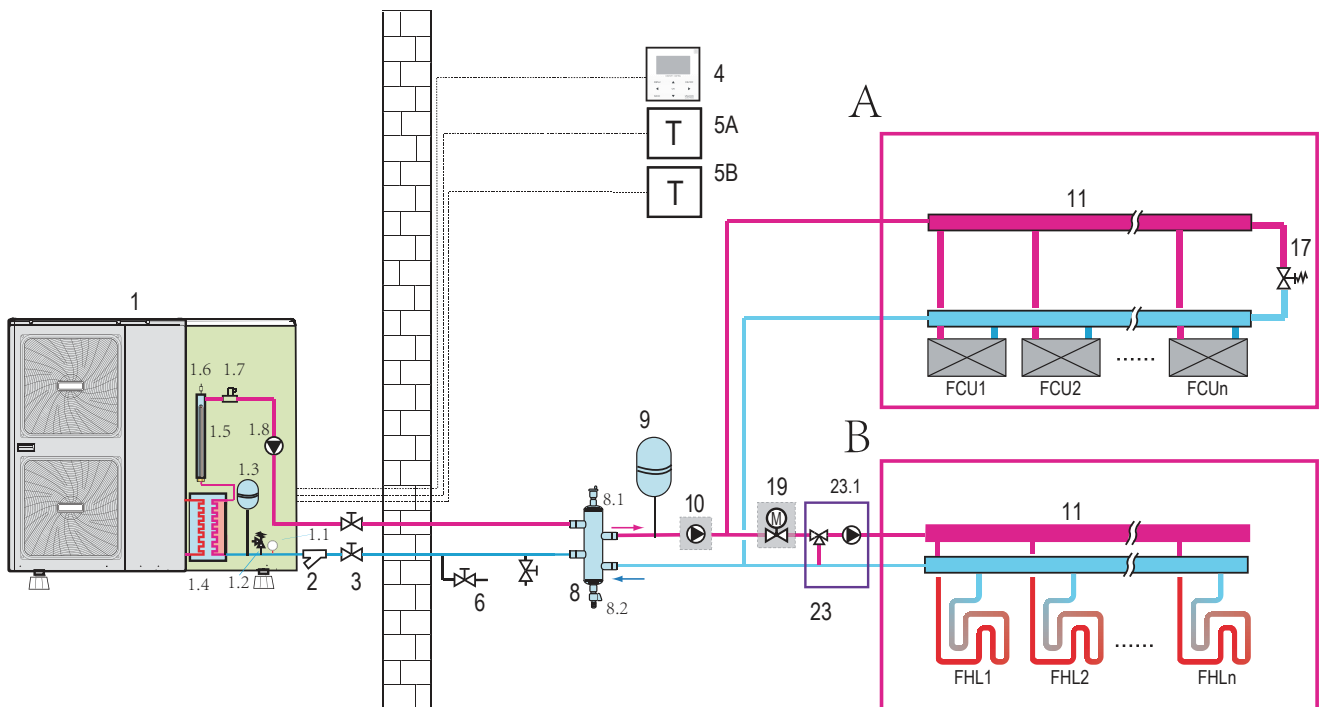

- | | |
|---------------------------------------|-------------------------------------------------|
| 1 outdoor unit | 8 balance tank (field supply) |
| 1.1 manometer | 8.1 air purge valve |
| 1.2 pressure relief valve | 8.2 drain valve |
| 1.3 expansion vessel | 9 expansion vessel (field supply) |
| 1.4 plate heat exchanger | 10 P_o: outside circulation pump (field supply) |
| 1.5 backup heater | 11 collector (field supply) |
| 1.6 air purge valve | 17 bypass valve (field supply) |
| 1.7 flow switch | 19 SV2:2-way valve (field supply) |
| 1.8 P_i: circulation pump in the unit | 23 mixing station (field supply) |
| 2 y-shape filter | 23.1 P_c: mixing pump |
| 3 stop valve (field supply) | FHL 1...n floor heating loop |
| 4 user interface | FCU 1...n fan coil units |
| 6 drain valve (field supply) | |
| 7 fill valve (field supply) | |



NOTE

The volume of balance tank(8) should be greater than 40L(for 5~9kW unit, greater than 20L) The drain valve (6) should be installed at the lowest position of the system. For 5/7/9kW unit, the backup heater (1.5) is not integrated in the outdoor unit. An independent backup heater can be selected and installed in the door. pump(10) and pump(23.1) should be controlled by outdoor unit and connect to corresponding port in the outdoor unit(refer to **9.6.6 Connection for other components/For outside circulation pump P_o and For tank loop pump P_d and mix pump P_c**).

The advantage of the dual set point control is that the heat pump will/can operate at the lowest required water flow temperature when only floor heating is required. Higher water flow temperatures are only required in case fan coil units are operating. This results in better heat pump performance.

Pump operation and space heating

The pump (1.8) and (10) will operate when there is request for heating from A and/or B. pump (23.1) will operate only when there is request for heating from B. The outdoor unit will start operating to achieve the target water flow temperature. The target water leaving temperature depends on which room thermostat is requesting heating.

When the room temperature of both zones is above the thermostat set point, the outdoor unit and pump will stop operating.



NOTE

- Make sure to correctly configure the room thermostat installation on the user interface. Refer to "**10.7 Field settings/ROOM THERMOSTAT**".
- It is the installers' responsibility to ensure that no unwanted situations can occur (e.g. extremely high temperature water going towards floor heating loops, etc.)
- The supplier does not offer any type of mixing station. Dual set point control only provides the possibility to use two set points.
- When only zone A requests heating, zone B will be fed with water at a temperature equal to the first set point. This can lead to unwanted heating in zone B.
- When only zone B requests heating, the mixing station will be fed with water at a temperature equal to the second set point. Depending on the control of the mixing station, the floor heating loop can still receive water at a temperature equal to the set point of the mixing station.
- Be aware that the actual water temperature through the floor heating loops depends on the control and setting of the mixing station.

8.7 Application 7

Dual setpoint function application without room thermostat connect to the outdoor unit.

- Heating is provided through floor heating loops and fan coil units. The floor heating loops and fan coil units require different operating water temperatures.
- The floor heating loops require a lower water temperature in heating mode compared to fan coil units. To achieve these two set points, a mixing station is used to adapt the water temperature according to requirements of the floor heating loops. The fan coil units are directly connected to the unit water circuit and the floor heating loops are after the mixing station. Control of this mixing station is not done by the unit.
- The operation and configuration of the field water circuit is the responsibility of the installer.
- We only offer a dual set point control function. This function allows two set points to be generated. Depending on the required water temperature (floor heating loops and/or fan coil units are required) the first set point or second set point can be activated. See **10.7 field setting /TEMP. TYPE SETTING**

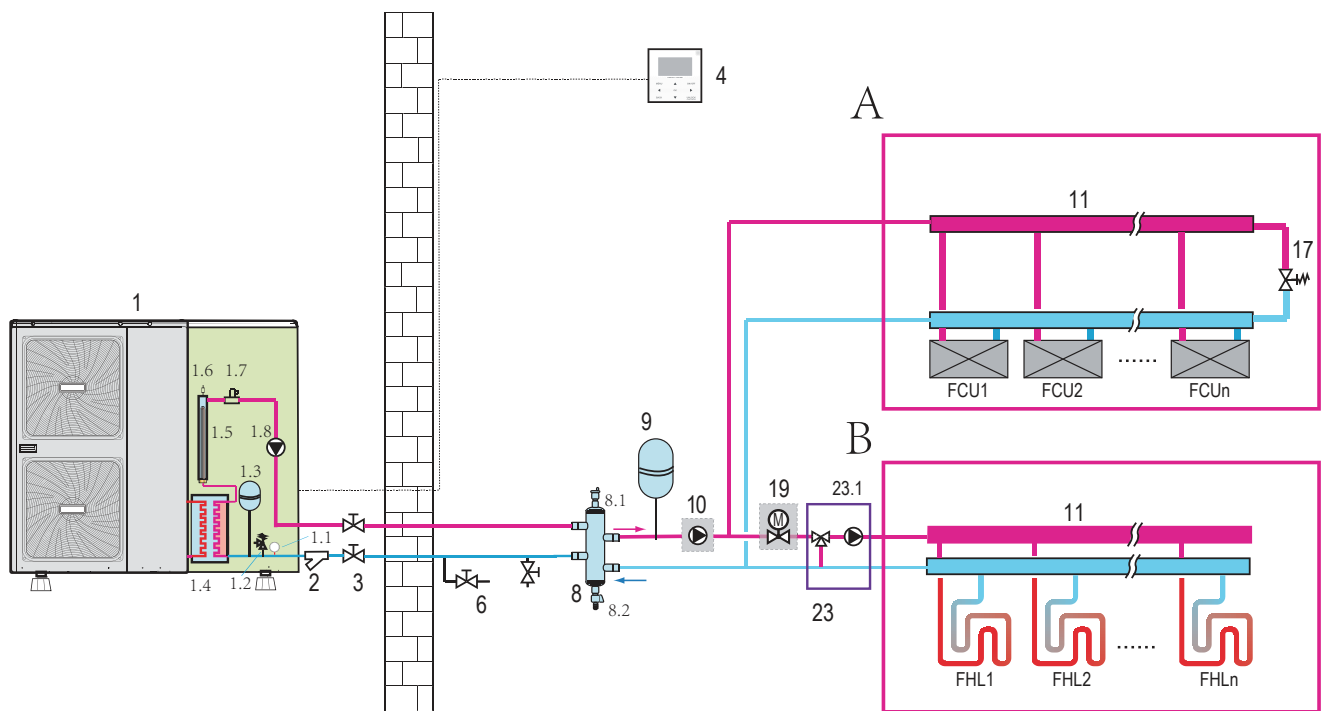

- | | | |
|-------------------------------------|---------------------------------------------|-----------------------------------|
| 1 outdoor unit | 3 stop valve(field supply) | 11 collector(field supply) |
| 1.1 manometer | 4 user interface | 17 bypass valve(field supply) |
| 1.2 pressure relief valve | 6 drain valve(field supply) | 19 SV2:2-way valve (field supply) |
| 1.3 expansion vessel | 7 fill valve(field supply) | 23 mixing station (field supply) |
| 1.4 plate heat exchanger | 8 balance tank(field supply) | 23.1 P_c: mixing pump |
| 1.5 backup heater | 8.1 air purge valve | FHL 1...n floor heating loop |
| 1.6 air purge valve | 8.2 drain valve | FCU 1...n fan coil units |
| 1.7 flow switch | 9 expansion vessel(field supply) | |
| 1.8 P_i: circulate pump in the unit | 10 P_o:outside circulate pump(field supply) | |
| 2 y-shape filter | | |



NOTE

The volume of balance tank(8) should be greater than 40L(for 5~9kW unit, greater than 20L) The drain valve (6) should be installed at the lowest position of the system. For 5/7/9kW unit, the backup heater (1.5) is not integrated in the outdoor unit. An independent backup heater can be selected and installed in the door.

As the temperature sensor attached in the user interface is used to detect the room temperature, the user interface (4) should be placed in the room where floor heating loops and fan coil units is installed and away from the heating source. Correct configuration should be applied in the user interface (refer to **10.7 field settings/TEMP. TYPE SETTING**). The first setpoint is water temperature which can be set on the main page of user interface, the second setpoint is calculated from climate related curves, the target outlet water temperature is the higher one of these two setpoint. the unit will turn off when the room temperature reaches the target temperature.

Pump operation and space heating

The pump (1.8) and (10) will operate when there is request for heating from A and/or B. pump (23.1) will operate when the room temperature of zone B is lower than the set point which set in the user interface. The outdoor unit will start operating to achieve the target water flow temperature.

8.8 Application 8

Space heating application and domestic hot water heating with a solar energy kit connect to the system, space heating is provided by heat pump, domestic hot water heating is provided by heat pump and solar energy kit.

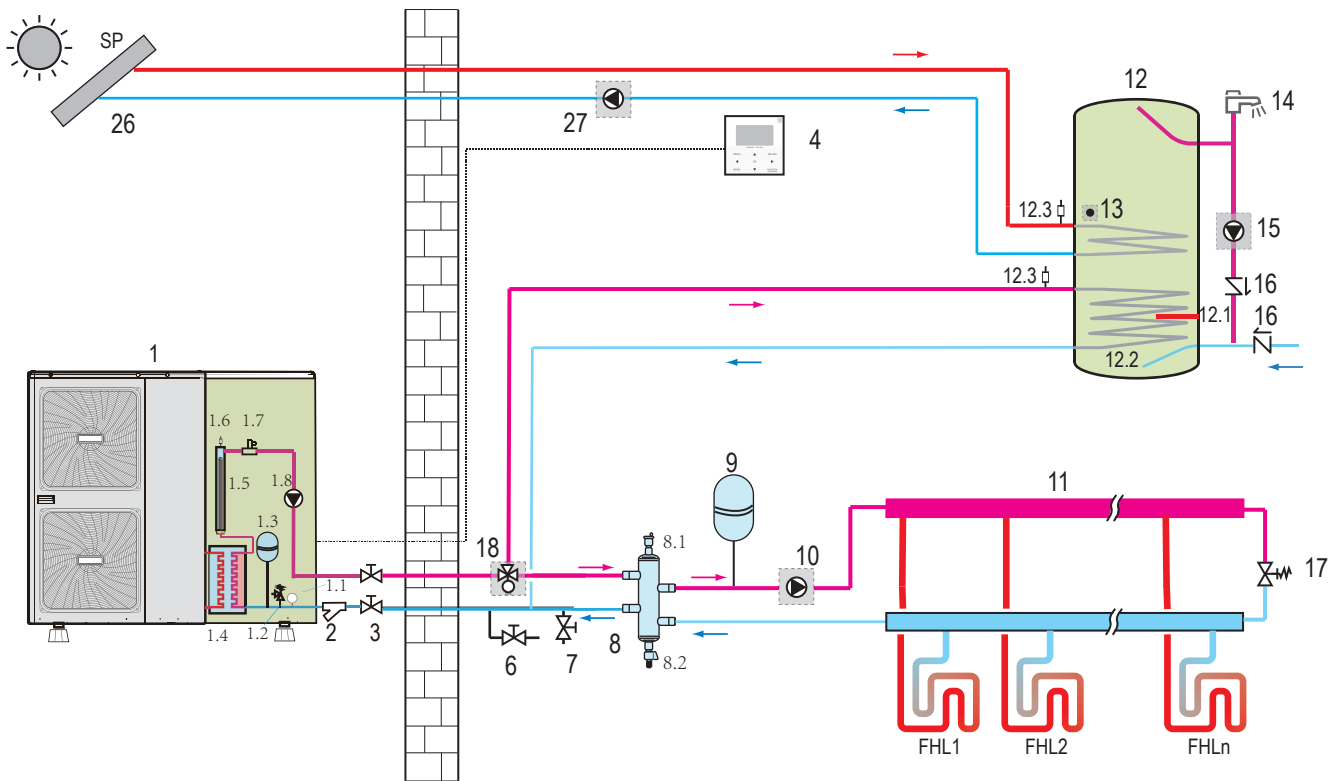

- | | | |
|-------------------------------------|----------------------------------------------|-----------------------------------|
| 1 outdoor unit | 4 user interface | 12.1 booster heater |
| 1.1 manometer | 6 drain valve(field supply) | 12.2 heat exchanger coil |
| 1.2 pressure relief valve | 7 fill valve(field supply) | 12.3 air purge valve |
| 1.3 expansion vessel | 8 balance tank(field supply) | 13 T5:temperature sensor |
| 1.4 plate heat exchanger | 8.1 air purge valve | 14 hot water tap(field supply) |
| 1.5 backup heater | 8.2 drain valve | 15 P_d: DHW pump(field supply) |
| 1.6 air purge valve | 9 expansion vessel(field supply) | 16 non-return valve(field supply) |
| 1.7 flow switch | 10 P_o: outside circulate pump(field supply) | 17 bypass valve(field supply) |
| 1.8 P_j: circulate pump in the unit | 11 collector(field supply) | 18 SV1: 3-way valve(field supply) |
| 2 y-shape filter | 12 domestic hot water tank(optional) | FHL 1...n floor heating loop |
| 3 stop valve(field supply) | | 26 Solar energy kit(field supply) |
| | | 27 P_s: Solar pump(field supply) |

NOTE

The volume of balance tank(8) should be greater than 40L(for 5~9kW unit, greater than 20L) The drain valve (6) should be installed at the lowest position of the system. For 5/7/9kW unit, the backup heater (1.5) is not integrated in the outdoor unit. An independent backup heater can be selected and installed in the door.

The pump (1.8) and (10) will operate when there is a request for heating floor heating loops. The outdoor unit will start operating to achieve the target water flow temperature. The target water can be set in the user interface. if solar energy is set available in the user interface(refer to **10.7 Field settings/OTHER HEATING SOURCE**), the heating of domestic hot water can be done by either the solar energy kit or heat pump. when the solar energy kit turns on, signal will sent to the outdoor unit, then the pump (27) will operate, the heat pump will stop heating for domestic hot water during solar energy kit operation .

NOTE

Make sure to wiring the solar energy kit(26) and solar pump(27) correctly, refer to **"9.6.6 Connection for other components/For solar energy kit"**. User interface should be correctly configured, refer to **"10.7 Field settings/OTHER HEATING SOURCE"**.

9 OVERVIEW OF THE UNIT

9.1 Opening the unit

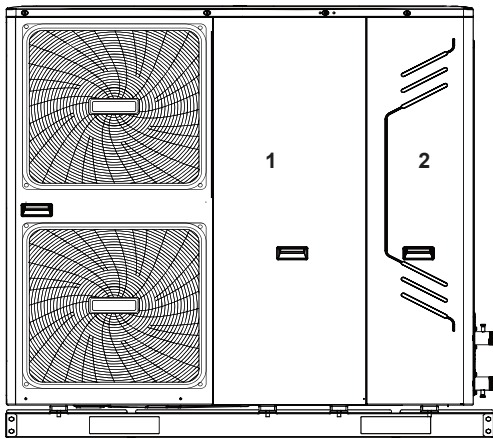

Door 1 gives access to the compressor compartment and electrical parts.

Door 2 gives access to the hydraulic compartment and electrical parts.

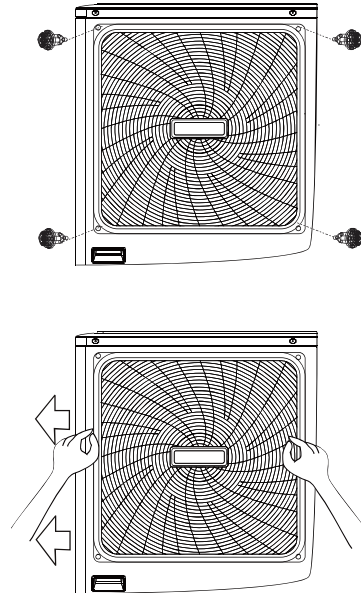
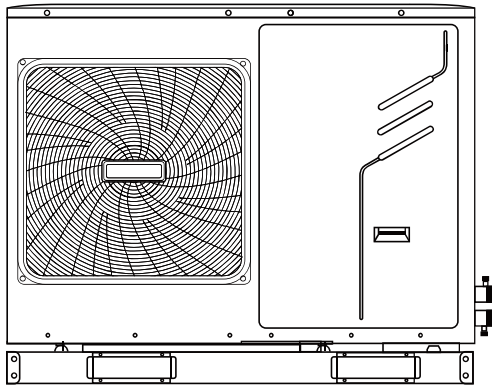

9.2 Main components

9.2.1 Hydraulic compartment

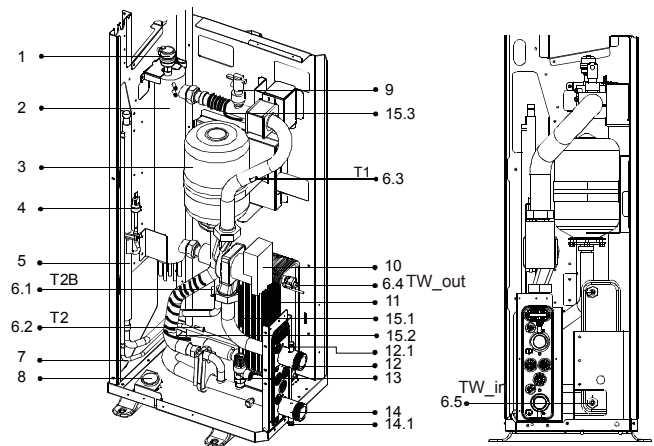

1-phase 10~16kW
3-phase 12~16kW



WARNING

Switch off all power — i.e. unit power supply and backup heater and domestic hot water tank power supply (if applicable) — before removing doors 1 and 2.



CAUTION

Parts inside the unit may be hot.

Push the grill to the left until it stops. then pull its right edge, the grill can now be removed. You can also reverse the procedure. Exercise caution to avoid a possible hand injury.

1. Air purge valve
Remaining air in the water circuit will be automatically removed via the air purge valve.

2. Backup heater
The backup heater consists of an electrical heating element that will provide additional heating capacity to the water circuit if the heating capacity of the unit is insufficient due to low outdoor temperatures. It also protects the external water piping from freezing.

3. Expansion vessel (1.32 gallons (5 L))

4. Pressure Sensor

5. Refrigerant gas connection

6. Temperature sensors

Four temperature sensors determine the water and refrigerant temperature at various points in the water circuit.

6.1-T2B; 6.2-T2; 6.3-T1; 6.4-TW_out; 6.5-TW_in

7. Refrigerant liquid connection

8. Manometer

The manometer provides a water pressure readout of the water circuit

9.Flow switch

The flow switch checks the flow in the water circuit and protects the heat exchanger against freezing and the pump against damage.

10.Pump

The pump circulates the water in the water circuit.

11.Heat exchanger

The manometer provides a water pressure readout of the water circuit.

12.Water outlet connection

12.1 Air purge valve

13.Pressure relief valve

The pressure relief valve prevents excessive water pressure in the water circuit by opening at 43.5 psi (3 bar) and discharges water.

14.Water inlet connection

14.1 Drain valve

15.Electrical heating tape(15.1-15.3)

9.2.2 Functional diagram of hydraulic compartment

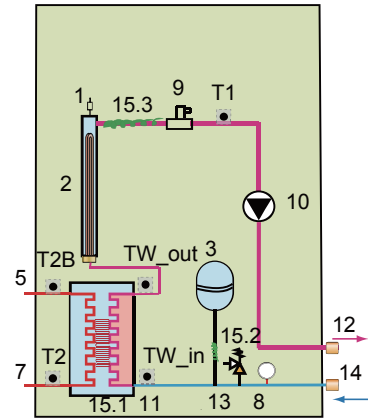

1-phase 10~16kW
3-phase 12~16kW

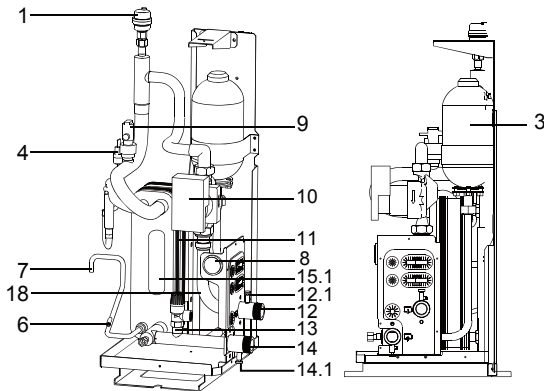

1-phase 5/7/9kW

1.Air purge valve

Remaining air in the water circuit will be automatically removed via the air purge valve.

3.Expansion vessel (0.88gallons (2 L))

4.Pressure Sensor

6.Temperature sensors

Four temperature sensors determine the water and refrigerant temperatures at various points in the water circuit.

7.Refrigerant liquid connection

8.Manometer

The manometer provides a water pressure readout of the water circuit.

9.Flow switch

The flow switch checks the flow in the water circuit and protects the heat exchanger against freezing and the pump against damage.

10.Pump

The pump circulates the water in the water circuit.

11.Heat exchanger

12.Water outlet connection

12.1 Air purge valve

13.Pressure relief valve

The pressure relief valve prevents excessive water pressure in the water circuit by opening at 43.5 psi (3 bar) and discharging water.

14.Water inlet connection

14.1 Drain valve

15.1.Electrical heating tape

18. sleeve for insert temperature sensor

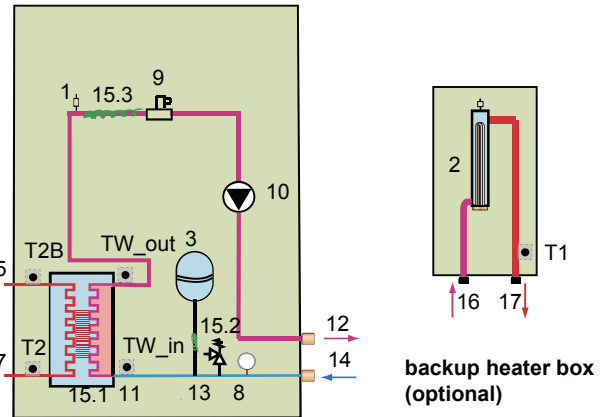

1-phase 5/7/9kW

1 Air purge valve

2 Backup heater vessel with backup heater

3 Expansion vessel

5 Refrigerant gas connection

7 Refrigerant liquid connection

8 Manometer

9 Flow switch

10 Circulation Pump

11 Heat exchanger

12 Water outlet connection

13 Pressure relief valve

14 Water inlet connection

15.1 Electrical heating tape

15.2 Electrical heating tape

15.3 Electrical heating tape

16 Water inlet connection

17 Water outlet connection

Temperature sensors:TW_in;TW_out;T2B;T2;T1

NOTE: for 5/7/9 kW unit,If backup heater box is installed, the port (CN6) for T1 in the main control board of hydraulic should connect to the corresponding port in the backup heater box(please refer to the **Installation & Owner's Manual** of backup heater box). if backup heater box is not installed, the T1 sensor should insert into the sleeve which near the pump(10) and connect to the port CN6.

Control box for 5/7/9 kW UNIT

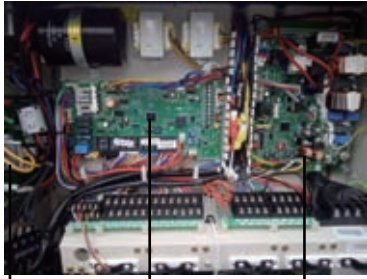

PCB A Main control board of hydraulic module PCB B

Control box for 10~16KW UNIT

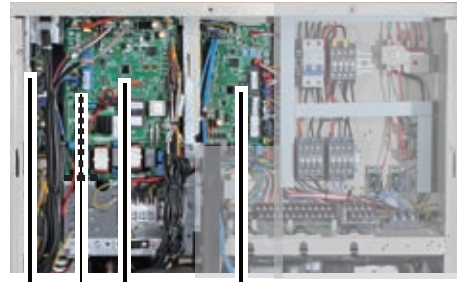

PCB A PCB B main control board of hydraulic module
PCB C (at back of the PCB B, only for 3 phase unit)

The image shown here is indicative only. If there is inconsistency between the image and the actual product, the actual product shall govern.

9.2.3 Main control board of hydraulic module

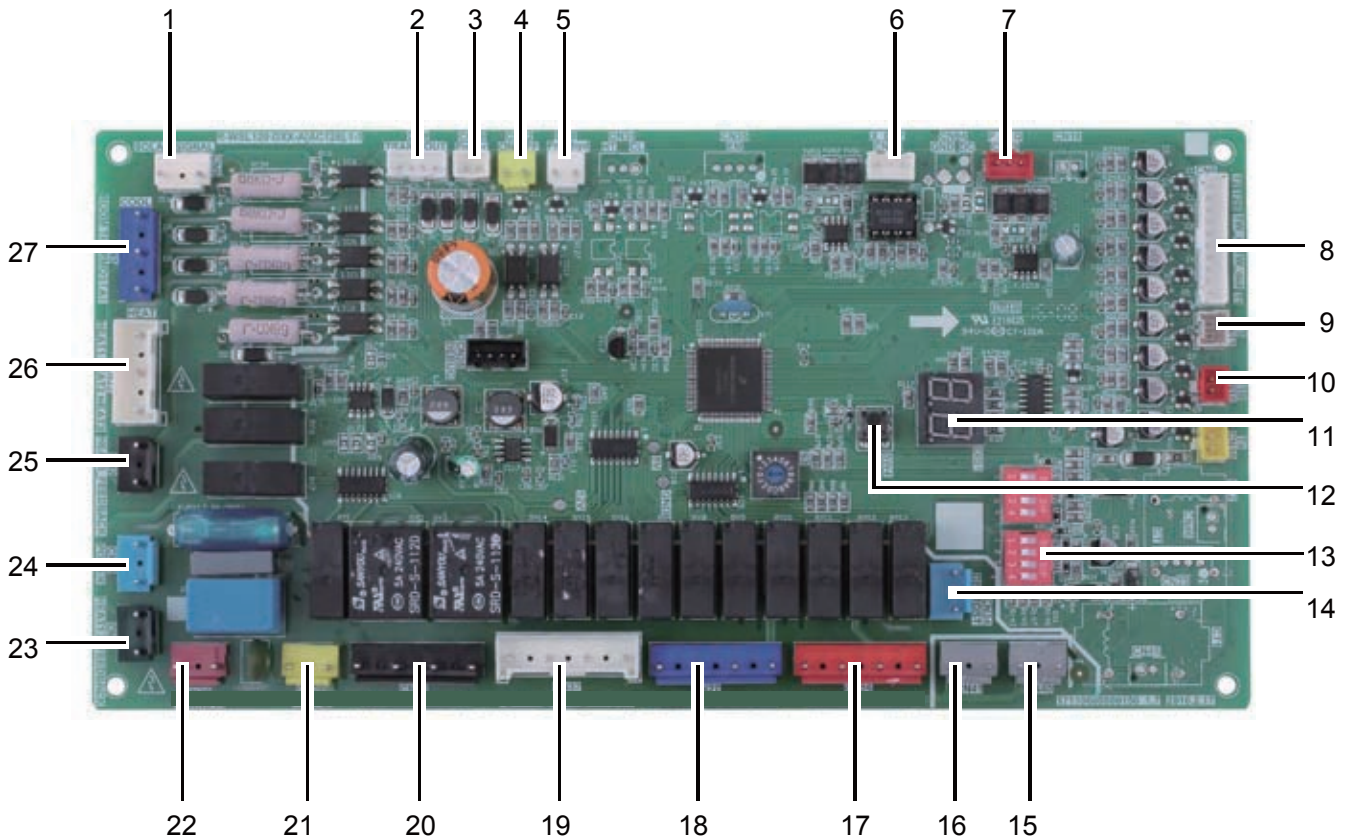

1-phase 5/7/9kW
1-phase 10~16kW
3-phase 12~16kW

- | | |
|--------------------------------------------------------------------------------------------------------------------------------------------------------------------------------------------------------------------------------------------------------------------------------------------------------------------------------------------------------------------------------------------------------------------------------------------------------------------------------------------------------------------------------------------------------------------------------------------------------------------------------------------------------------------------------------------------------------------------------------------------------------------------------------------------|--------------------------------------------------------------------------------------------------------------------------------------------------------------------------------------------------------------------------------------------------------------------------------------------------------------------------------------------------------------------------------------------------------------------------------------------------------------------------------------------------------------------------------------------------------------------------------------------------------------------------------------------------------------------------------------------------------------------------------------------------------------------------------------------------------------------------------------------------------------------------------|
| <ul style="list-style-type: none"> 1 Input port for solar energy(CN5) 2 Output port for transformer(CN4) 3 Power supply port for user interface(CN36) 4 Port for remote switch(CN12) 5 Port for flow switch (CN8) 6 Communicate port between this PCB and user interface(CN14) 8 Port for temperature sensors(TW_out, TW_in, T1, T2,T2B)(CN6) 9 Port for temperature sensor(T5, domestic hot water tank temp.) (CN13) 10 Port for temperature sensor(T1B, the final outlet temp.)(CN15) 11 Digital displays(DIS1) 12 Check button(SW4) 13 DIP switch(S1,S2) 14 output port for deforst(CN34) 15 Port for anti-freeze electric heating tape (internal)(CN40) | <ul style="list-style-type: none"> 16 Port for anti-freeze electric heating tape (internal)(CN41) 17 Output port for external heating source / operation output port(CN25) 18 Port for anti-freeze electric heating tape(external) /port for solar energy pump/output port for remote alarm(CN27) 19 Port for external circulted pump (P_o) /pipe pump(P_d)/mix pump(P_c)/2-way valve SV2(CN37) 20 Port for SV1(3-way valve) and SV3(CN24) 21 Port for internal pump(CN28) 22 Input port for transformer(CN20) 23 Feedback port for temperature switch(CN1) 24 Port for power supply(CN21) 25 Feedback port for external temp. switch(shorted in default)(CN2) 26 Control port backup heater/booster heater(CN22) 27 Control port for room thermostat(CN3) |
|--------------------------------------------------------------------------------------------------------------------------------------------------------------------------------------------------------------------------------------------------------------------------------------------------------------------------------------------------------------------------------------------------------------------------------------------------------------------------------------------------------------------------------------------------------------------------------------------------------------------------------------------------------------------------------------------------------------------------------------------------------------------------------------------------|--------------------------------------------------------------------------------------------------------------------------------------------------------------------------------------------------------------------------------------------------------------------------------------------------------------------------------------------------------------------------------------------------------------------------------------------------------------------------------------------------------------------------------------------------------------------------------------------------------------------------------------------------------------------------------------------------------------------------------------------------------------------------------------------------------------------------------------------------------------------------------|

9.2.4 PCB for refrigerant system

PCB A, Inverter module for 1-phase 10~16kW unit

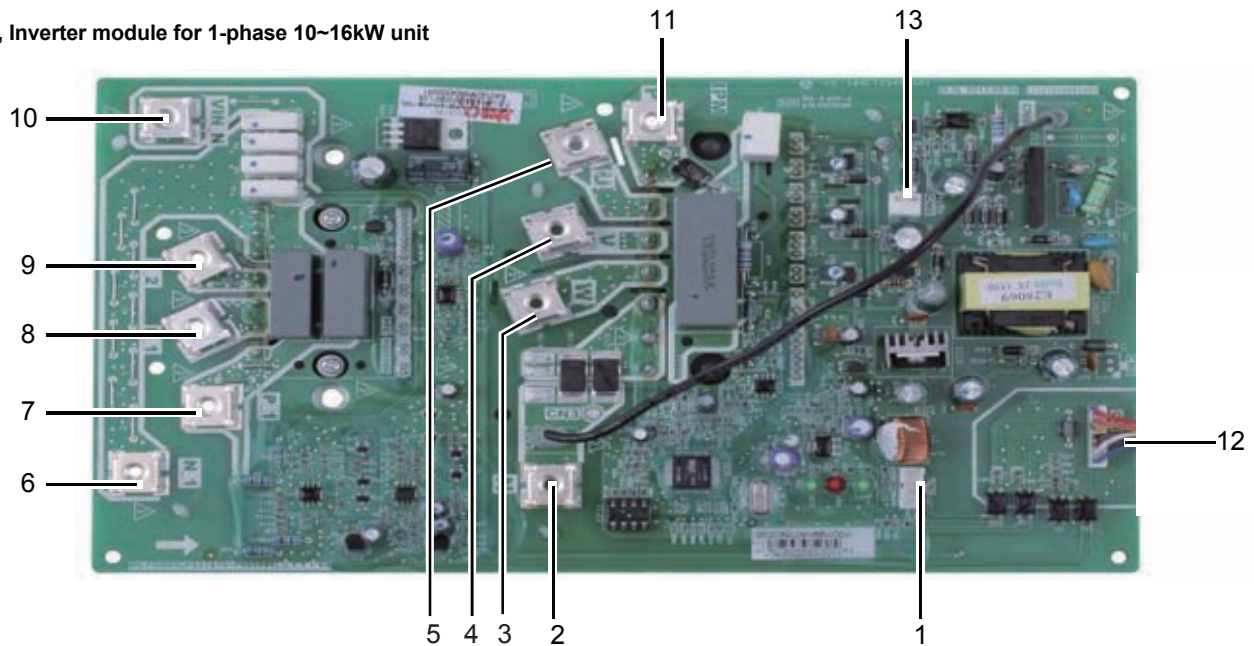

- | | | | | | |
|---|-------------------------------------------|---|-------------------------------------------|----|-----------------------------------------------|
| 1 | Reserved(CN2) | 5 | Power Supply Of U Phase For Compressor(U) | 10 | Input Port N For PFC Module(VIN-N) |
| 2 | Input Port N For IPM Module(N) | 6 | Output Port N Of PFC Module(N_1) | 11 | Input Port P For IPM Module(P) |
| 3 | Power Supply Of W Phase For Compressor(W) | 7 | Output Port P Of PFC Module(P_1) | 12 | Communicate Port Between PCB A And PCB B(CN1) |
| 4 | Power Supply Of V Phase For Compressor(V) | 8 | Input Port For PFC Inductance L_1(L_1) | 13 | +15V(CN6) |
| | | 9 | Input Port For PFC Inductance L_2(L_2) | | |

PCB B, Main control board for 1-phase 10~16kW unit

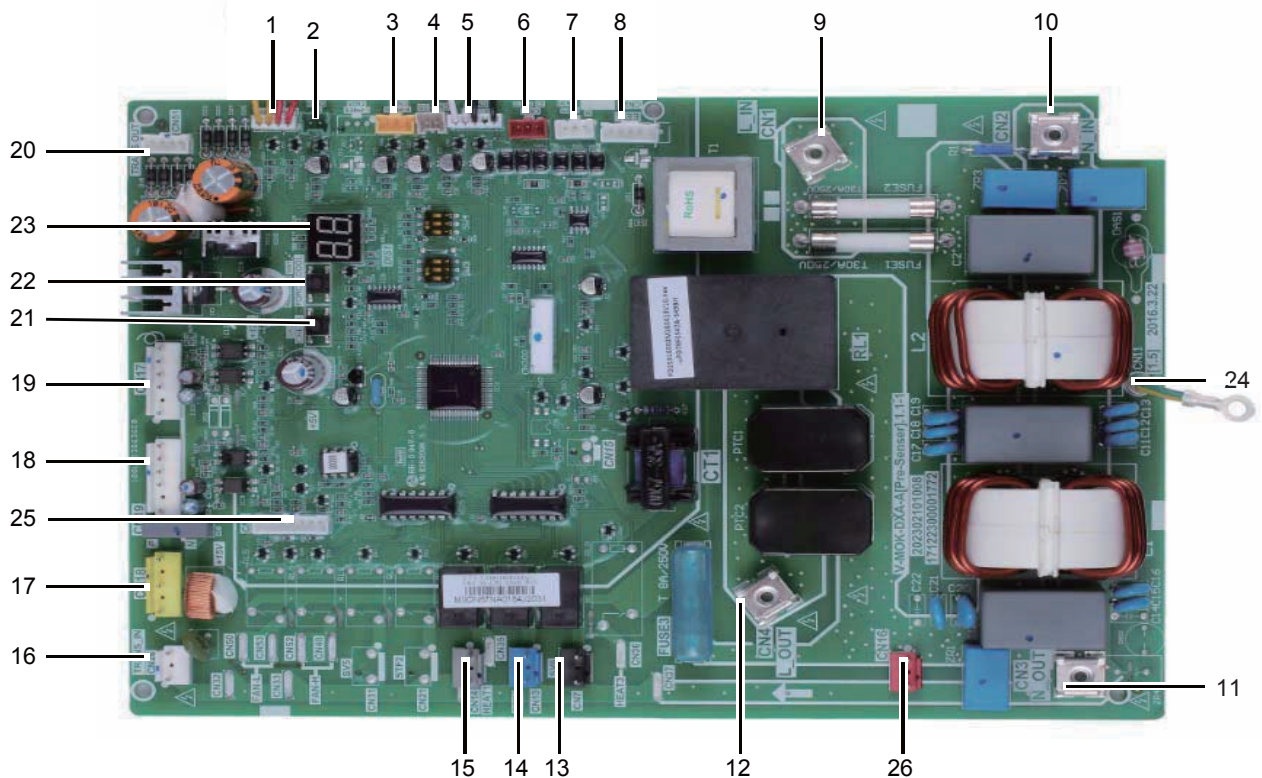

- | | | | | | |
|---|---------------------------------------------------------------------------|----|-------------------------------------------|----|-----------------------------------------------------|
| 1 | Port For Pressure Switch(CN12) | 7 | Reserved(CN30) | 17 | Power Supply Port For Fan(CN18) |
| 2 | Port For Suction Temperature Sensor(CN24) | 8 | Port For Electrical Expansion Value(CN22) | 18 | Port For Down Fan(CN19) |
| 3 | Port For Pressure Sensor(CN28) | 9 | Input Port For Live Wire(CN1) | 19 | Port For Up Fan(CN17) |
| 4 | Port For Discharge Temperature Sensor(CN8) | 10 | Input Port For Neutral Wire(CN2) | 20 | Output Port For Transformer(CN51) |
| 5 | Port For Ambient Temperature And Condenser Outlet Temperature Sensor(CN9) | 11 | Output Port For Neutral Wire(CN3) | 21 | Check Button(SW2) |
| | | 12 | Ourput Port For Live Wire(CN4) | 22 | Refrigerant Recovery Button |
| | | 13 | Reserved(CN7) | 23 | Digital Displays(DIS1) |
| | | 14 | Port For 4-way Value(CN13) | 24 | Ground Wire(CN11) |
| | | 15 | Port For Eletric Heating Tape(CN14) | 25 | Communication Port For PCB A(CN6) |
| | | 16 | Input Port For Transformer(CN26) | 26 | Power supply port for hydro-box control board(CN16) |

Controls parts for backup heater (IBH)

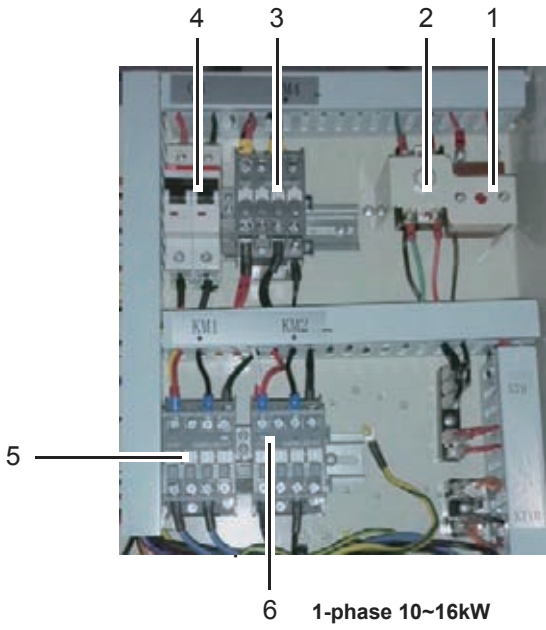

- 1 Auto thermal protector
- 2 Manu thermal protector
- 3 Backup heater contactor KM4
- 4 Backup heater circuit breaker CB
- 5 Backup heater contactor KM1
- 6 Backup heater contactor KM2

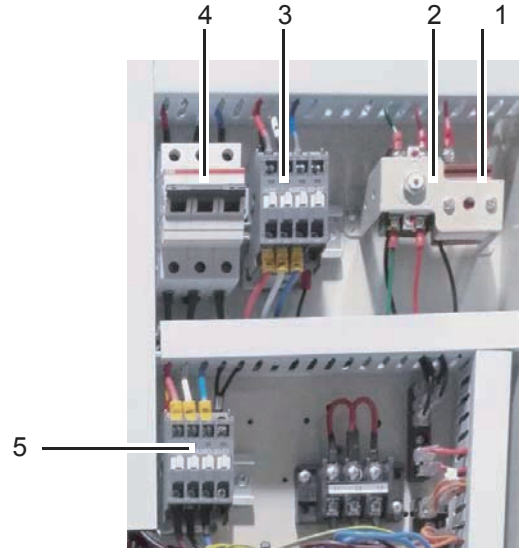

3-phase 12~16kW

- 1 Auto thermal protector
- 2 Manu thermal protector
- 3 Backup heater contactor KM4
- 4 Backup heater circuit breaker CB
- 5 Backup heater contactor KM1

PCB C, filter board for 3 phase 12~16kw unit, door 1

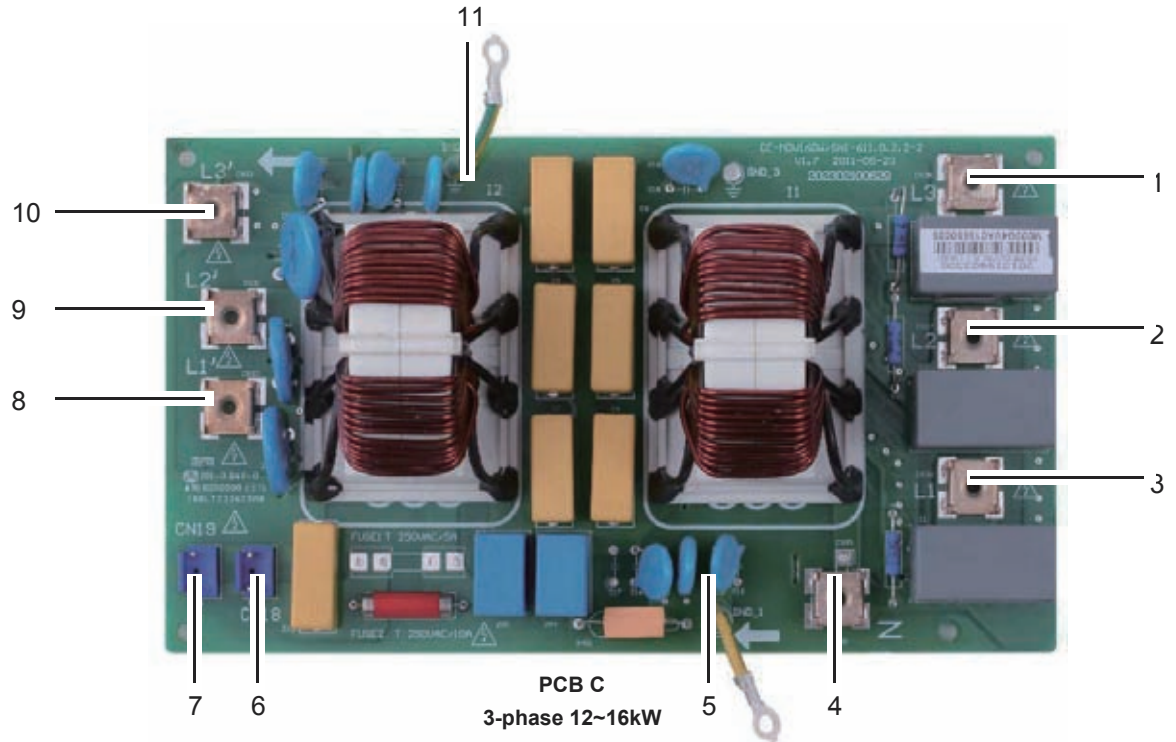

**PCB C
3-phase 12~16kW**

- 1 Power supply L3(L3)
- 2 Power supply L2(L2)
- 3 Power supply L1(L1)
- 4 Power supply N(N)
- 5 Ground wire(GND_1)
- 6 Power supply for load(CN18)
- 7 Power supply for main control board(CN19)
- 8 Power filtering L1(L1')
- 9 Power filtering L2(L2')
- 10 Power filtering L3(L3')
- 11 Ground wire(GND_2)

PCB B, Main control board for 3-phase 12~16kW unit

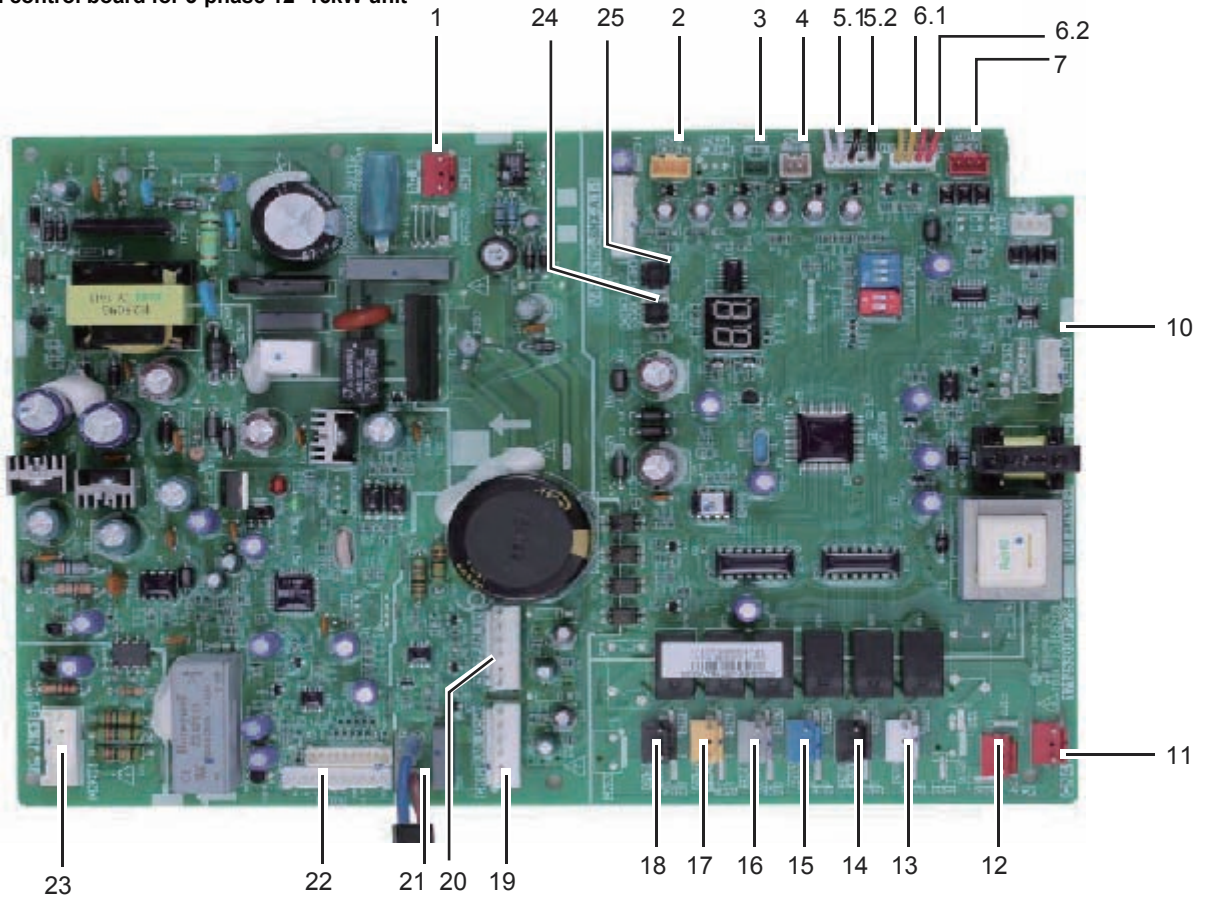

- | | | |
|-------------------------------------------------------|--------------------------------------------------|------------------------------------------|
| 1 Power supply for the main PCB(CN250) | 10 Port for electrical expansion value(CN22) | 18 Reserved(CN68) |
| 2 Port for pressure sensor(CN36) | 11 Port for power supply(CN41) | 19 Port for down fan(CN19) |
| 3 Port for suction temperature sensor(CN4) | 12 Power supply for hydro-box control board(CN6) | 20 Port for up fan(CN17) |
| 4 Port for discharge temperature sensor(CN8) | 13 PFC control port(CN63) | 21 Power supply port for module(CN70/71) |
| 5.1 Port for outdoor temperature sensor(CN9) | 14 Reserved(CN64) | 22 Communication port for PCB A(CN201) |
| 5.2 Port for condenser outlet temperature sensor(CN9) | 15 Port for 4-way valve(CN65) | 23 Port for voltage check(CN205) |
| 6.1 Port for high pressure switch(CN6) | 16 Port for electric heating tape(CN66) | 24 Refrigerant recovery button(SW1) |
| 6.2 Port for low pressure switch(CN6) | 17 PTC control(CN67) | 25 Check button(SW2) |

PCB A, Inverter module for 3-phase 12~16kW unit

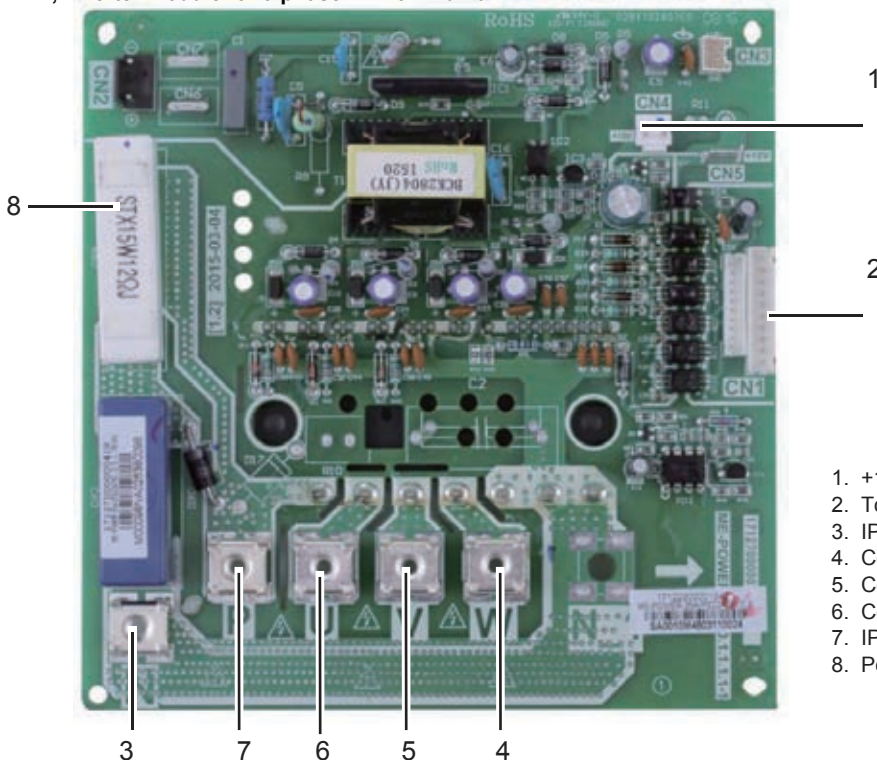

- | |
|------------------------------------------|
| 1. +15V port(CN4) |
| 2. To MCU(CN1) |
| 3. IPM input N |
| 4. Compressor connection port W |
| 5. Compressor connection port V |
| 6. Compressor connection port U |
| 7. IPM input P |
| 8. Power for switching power supply(CN2) |

3-phase PCB A

PCB A, Inverter board for 1 phase 5/7/9 kW unit.

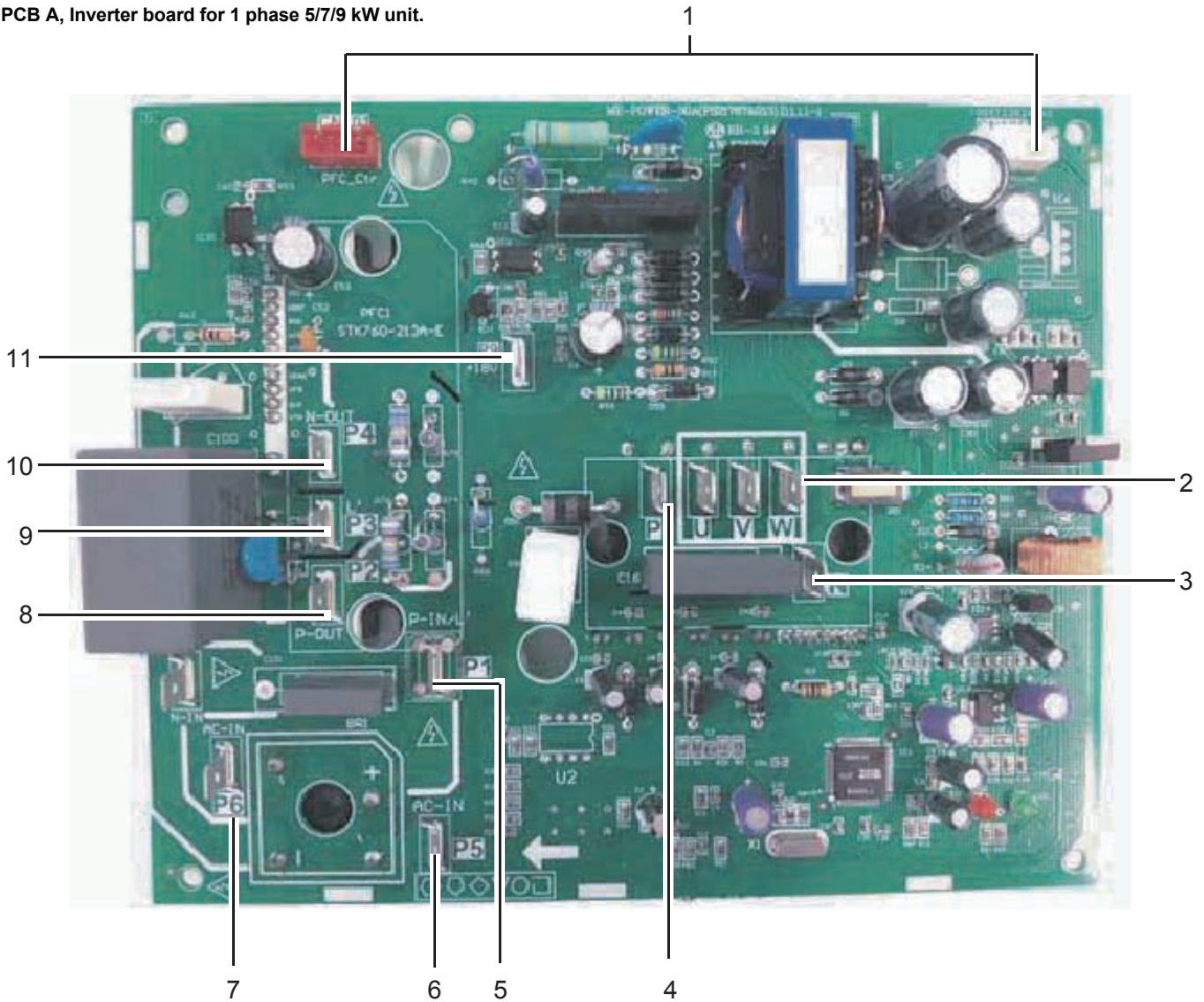

1-phase 5/7/9kW

- 1 To main board (CN101,CN105)
- 2 Compressor connection port U V W (U,V,W)
- 3 Input port N for IPM module(N)
- 4 Input port P for IPM module(P)
- 5 Input port for PFC inductance P1(P1)
- 6 Input port for bridge Rectifiers(P5)
- 7 Input port for Bridge Rectifiers(P6)
- 8 Output port P of PFC(P2)
- 9 Input port for PFC inductance 3(P3)
- 10 Output port N of PFC(P4)
- 11 +18V(P9)

PCB B, Main control board for 1 phase 5/7/9 kW unit.

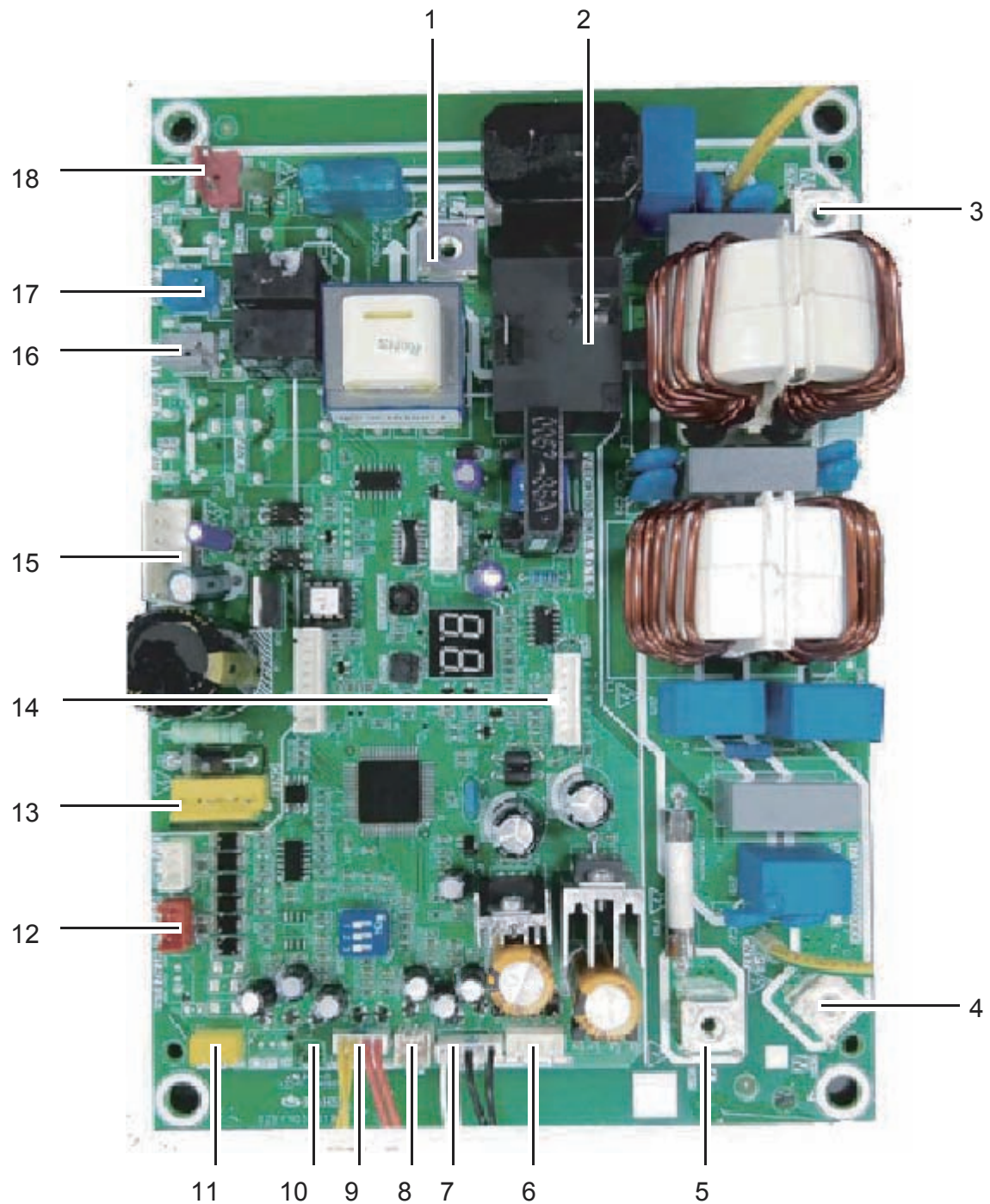

1-phase 5/7/9kW

- | | |
|-------------------------------------------------------------------------|---------------------------------------------------------------------------------------|
| 1 Rectifier bridge input port L | 10 Th temperature sensor port |
| 2 Hydraulic compartment input port2 | 11 Pressure sensor port |
| 3 Rectifier bridge input port N | 12 Port for communication between this PCB and main control board of hydraulic module |
| 4 Power supply N | 13 P/N/+18V port |
| 5 Power supply L | 14 To IPDU/PFC |
| 6 Transformer output port | 15 DC fan port |
| 7 BLACK: T3 temperature sensor port
WHITE:T4 temperature sensor port | 16 Compression electromechanical heating belt |
| 8 TP temperature sensor port | 17 4-way valve port |
| 9 YELLOW: High pressure switch
RED: Low pressure switch | 18 Transformer input port |

9.3 Water pipework

All piping lengths and distances have been taken into consideration.

Requirements	Valve
The maximum allowed thermistor cable length is 20m. This is the maximum allowable distance between the domestic hot water tank and the unit (only for installations with a domestic hot water tank). The thermistor cable supplied with the domestic hot water tank is 10m in length. In order to optimize efficiency we recommend installing the 3-way valve and the domestic hot water tank as close as possible to the unit	Thermistor cable length minus 2m



NOTE

- If the installation is equipped with a domestic hot water tank (optional), please refer to the domestic hot water tank Installation & Owner's Manual.
- If there is no glycol (anti-freeze) in the system there is a power supply or pump failure, drain the system (as shown in the figure below).

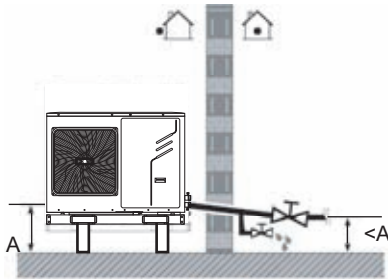

When water is not moving inside the system in cold weather, freezing is very likely and will damage the system.

Checking the water circuit

The units are equipped with a water inlet and outlet for connection to a water circuit. This circuit must be provided by a licensed technician and must comply with local laws and regulations.

The unit is only to be used in a closed water system. Application in an open water circuit can lead to excessive corrosion of the water piping.

Example

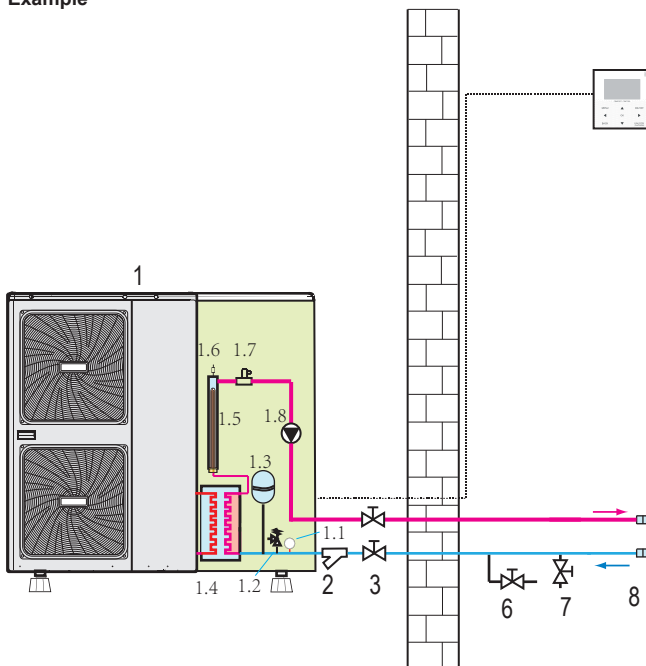

Before continuing installation of the unit, check the following:

- The maximum water pressure = 3 bar.
- The maximum water temperature is 70°C according to safety device setting.
- Always use materials that are compatible with the water used in the system and with the materials used in the unit.
- Ensure that components installed in the field piping can withstand the water pressure and temperature.
- Drain taps must be provided at all low points of the system to permit complete drainage of the circuit during maintenance.
- Air vents must be provided at all high points of the system. The vents should be located at points that are easily accessible for servicing. An automatic air purge is provided inside the unit. Check that this air purge valve is not tightened too much so that automatic release of air in the water circuit remains possible.

Checking the water volume and expansion vessel pre-pressure

The unit is equipped with a 5 L (for 5/7/9 kW unit, the volume is 2L) expansion vessel that has a default pre-pressure of 1.5 bar. To assure proper operation of the unit, the pre-pressure of the expansion vessel might need to be adjusted and the minimum and maximum water volume must be checked.

1. Check that the total water volume in the installation, excluding the internal water volume of the unit, is at least 25L (for 5/7/9 kW unit, the minimum volume is 15L). Refer to **14 Technical specifications** to find the total internal water volume of the unit.



NOTE

- In most applications this minimum water volume will be satisfactory.
- In critical processes or in rooms with a high heat load though, extra water might be required.
- When circulation in each space heating loop is controlled by remotely controlled valves, it is important that this minimum water volume is kept even if all the valves are closed.

- | | |
|---------------------------------------|-------------------------------------------------|
| 1 Outdoor Unit | 8 Balance Tank(Field Supply) |
| 1.1 Manometer | 8.1 Air Purge Valve |
| 1.2 Pressure Relief Valve | 8.2 Drain Valve |
| 1.3 Expansion Vessel | 9 Expansion Vessel (Field Supply) |
| 1.4 Plate Heat Exchanger | 10 P_o: Outside Circulation Pump (Field Supply) |
| 1.5 Backup Heater | 11 Collector(Field Supply) |
| 1.6 Air Purge Valve | 17 Bypass Valve(Field Supply) |
| 1.7 Flow Switch | FHL 1...N Floor Heating Loop |
| 1.8 P_i: Circulation Pump Inside Unit | |
| 2 Y-shape Filter | |
| 3 Stop Valve (Field Supply) | |
| 4 User Interface | |
| 6 Drain Valve(Field Supply) | |
| 7 Fill Valve(Field Supply) | |

- Using the table below, determine if the expansion vessel pre-pressure requires adjustment.
- Using the table and instructions below, determine if the total water volume in the installation is below the maximum allowed water volume.

Installation height difference ^(a)	Water volume ≤72 L ^(b)	Water volume >72 L ^(b)
≤12 m	No pre-pressure adjustment required.	Actions required: <ul style="list-style-type: none"> pre-pressure must be decreased, calculate according to "Calculating the pre-pressure of the expansion vessel" check if the water volume is lower than maximum allowed water volume (use graph below)
>12 m	Actions required: <ul style="list-style-type: none"> Pre-pressure must be increased, calculate according to "Calculating the pre-pressure of the expansion vessel" below. Check if the water volume is lower than maximum allowed water volume (use graph below) 	Expansion vessel of the unit too small for the installation.

- Installation height difference: height difference (m) between the highest point of the water circuit and the unit. If the unit is located at the highest point of the installation, the installation height is considered to be 0 m.
- for 1-phase 10~16kW and 3-phase 12~16 kW unit, this value is 72L, for 5~9 kW unit, this value is 30 L.

Calculating pre-pressure of the expansion vessel

The pre-pressure (Pg) to be set depends on the maximum installation height difference (H) and is calculated as follows:
 $Pg(\text{bar}) = (H(\text{m})/10 + 0.3) \text{ bar}$

Checking the maximum allowed water volume

To determine the maximum allowed water volume in the entire circuit, proceed as follows:

- Determine the calculated pre-pressure (Pg) for the corresponding maximum water volume using the graph below.
- Check that the total water volume in the entire water circuit is lower than this value.

If this is not the case, the expansion vessel inside the unit is too small for the installation.

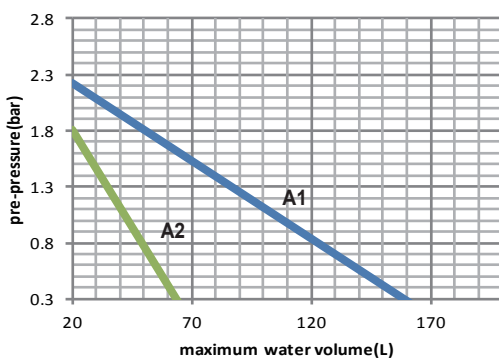

pre-pressure = pre-pressure of the expansion vessel
 maximum water volume = maximum water volume in the system

- A1 System without glycol for 1-phase 10~16 kW and 3-phase 12~16 kW unit
 A2 System without glycol for the 5/7/9 kW unit

Example 1

The unit(16kW) is installed 10m below the highest point in the water circuit. The total water volume in the water circuit is 50 L. In this example, no action or adjustment is required.

Example 2

The unit(16kW) is installed at the highest point in the water circuit. The total water volume in the water circuit is 150 L.

Result:

- Since 150 L is more than 72 L, the pre-pressure must be decreased (see table above).
- The required pre-pressure is:
 $Pg(\text{bar}) = (H(\text{m})/10 + 0.3) \text{ bar} = (0/10 + 0.3) \text{ bar} = 0.3 \text{ bar}$
- The corresponding maximum water volume can be read from the graph: approximately 160 L.
- Since the total water volume (150 L) is below the maximum water volume (160 L), the expansion vessel suffices for the installation.

Setting the pre-pressure of the expansion vessel

When it is required to change the default pre-pressure of the expansion vessel (1.5 bar), keep in mind the following guidelines:

- Use only dry nitrogen to set the expansion vessel pre-pressure.
- Inappropriate setting of the expansion vessel pre-pressure will lead to malfunctioning of the system. Pre-pressure should only be adjusted by a licensed installer.

Selecting the additional expansion vessel

If the expansion vessel of the unit is too small for the installation, an additional expansion vessel is needed.

- calculate the pre-pressure of the expansion vessel:

$$Pg(\text{bar}) = (H(\text{m})/10 + 0.3) \text{ bar}$$

the expansion vessel equipped in the unit should adjust the pre-pressure also.

- calculate the volume needed of the additional expansion vessel:

$$V1 = 0.0693 * V_{\text{water}} / (2.5 - Pg) - V0$$

V_{water} is volume of water in the system, V₀ is volume of expansion vessel which the unit is equipped (10~16kW, V₀=5L, 5~9kW, V₀=2L).

Connecting the water circuit

Water connections must be made in accordance with the outlook diagram delivered with the unit, with respect to the water intake and water outlet.



Be careful not to deform the unit's piping by using excessive force when connecting the piping. Deforming the piping can cause the unit to malfunction.

If air, moisture or dust gets in the water circuit, problems may occur. Therefore, always take into account the following when connecting the water circuit:

- Use clean pipes only.
- Hold the pipe end downwards when removing burrs
- Cover the pipe end when inserting it through a wall so that no dust and dirt enter.
- Use a good thread sealant for sealing the connections. The sealing must be able to withstand the pressures and temperatures of the system.
- When using non-brass metallic piping, make sure to insulate both materials from each other to prevent galvanic corrosion.
- Because brass is a soft material, use appropriate tools for connecting the water circuit. Inappropriate tools will cause damage to the pipes.

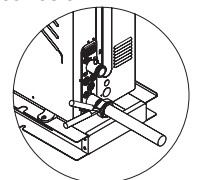



NOTE

The unit is only to be used in a closed water system. Application in an open water circuit can lead to excessive corrosion of the water piping:

- Never use Zn-coated parts in the water circuit. Excessive corrosion of these parts may occur as copper piping is used in the unit's internal water circuit.
- When using a 3-way valve in the water circuit. Preferably choose a ball type 3-way valve to guarantee full separation between the domestic hot water and floor heating water circuit.
- When using a 3-way valve or a 2-way valve in the water circuit. The recommended maximum changeover time of the valve should be less than 60 seconds.

Protecting the water circuit against freezing

Frost can cause damage to the hydraulic system. As this unit is installed outdoors and thus the hydraulic system is exposed to freezing temperatures, care must be taken to prevent freezing of the system.

All hydraulic parts are insulated to reduce heat loss. Insulation must be present on the field piping.

The unit is already equipped with several features to prevent freezing.

- The software contains special functions using the heat pump to protect the entire system against freezing. When the temperature of the water flow in the system drops to a certain value, the unit will heat the water, either using the heat pump, the electric heating tap, or the backup heater. The freeze protection function will turn off only when the temperature increases to a certain value.

In case of a power failure, the features mentioned above cannot protect the unit from freezing.

Since a power failure could happen when the unit is unattended, the supplier recommends adding glycol to the water system. Refer to "**Caution: Use of glycol**".

Depending on the expected lowest outdoor temperature, make sure the water system is filled with a concentration of glycol as mentioned in the table below.

When glycol is added to the system, the performance of the unit will be affected. The correction factor of the unit capacity, flow rate and pressure drop of the system is listed in the table below

Ethylene Glycol

Quality of glycol/%	Modification coefficient				Freezing point/°C
	Cooling capacity modification	Power modification	Water resistance	Water flow modification	
0	1.000	1.000	1.000	1.000	0.000
10	0.984	0.998	1.118	1.019	-4.000
20	0.973	0.995	1.268	1.051	-9.000
30	0.965	0.992	1.482	1.092	-16.000
40	0.960	0.989	1.791	1.145	-23.000
50	0.950	0.983	2.100	1.200	-37.000

Propylene Glycol

Quality of glycol/%	Modification coefficient				Freezing point/°C
	Cooling capacity modification	Power modification	Water resistance	Water flow modification	
0	1.000	1.000	1.000	1.000	0.000
10	0.976	0.996	1.071	1.000	-3.000
20	0.961	0.992	1.189	1.016	-7.000
30	0.948	0.988	1.380	1.034	-13.000
40	0.938	0.984	1.728	1.078	-22.000
50	0.925	0.975	2.150	1.125	-35.000

If no glycol is added, the water must be drained out when there is a power failure.

Water may enter into the flow switch and cannot be drained out and may freeze when the temperature is low enough. The flow switch should be removed and dried, then can be reinstalled in the unit.

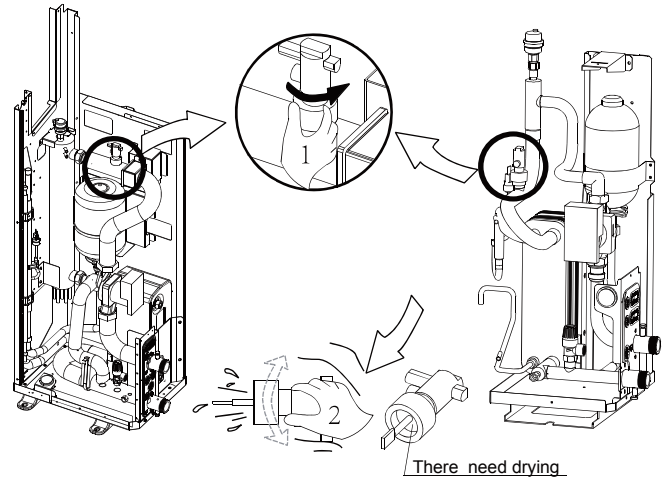

NOTE

- Counterclockwise rotation, remove the flow switch.
- Drying the flow switch completely.



WARNING

(a) ETHYLENE GLYCOL IS TOXIC

The concentrations mentioned in the table above will not prevent freezing, but will prevent the hydraulics from bursting.



CAUTION

Use of glycol

- Glycol use for installations with a domestic hot water tank:
 - Only propylene glycol having a toxicity rating or class of 1, as listed in "Clinical Toxicology of Commercial Products, 5th edition" may be used.
 - The maximum allowed water volume is then reduced according to the figure "Maximum allowed water volume" on page 27.
- If there is too much pressure when using glycol, connect the safety valve to a drain pan to recover the glycol.

Corrosion in the system due to glycol

Uninhibited glycol will turn acidic under the influence of oxygen. This process is accelerated by presence of copper and at higher temperatures. The acidic uninhibited glycol attacks metal surfaces and forms galvanic corrosion cells that cause severe damage to the system.

It is of extreme importance:

- That the water treatment is correctly executed by a qualified water specialist.
- That a glycol with corrosion inhibitors is selected to counteract acids formed by the oxidation of glycols.
- That in case of an installation with a domestic hot water tank, only the use of propylene glycol is allowed. In other installations the use of ethylene glycol is fine.
- That no automotive glycol is used because their corrosion inhibitors have a limited lifetime and contain silicates that can foul or plug the system;
- That galvanized piping is not used in glycol systems since it may lead to the precipitation of certain elements in the glycol's corrosion inhibitor;
- To ensure that the glycol is compatible with the materials used in the system.



NOTE

- Be aware of the hygroscopic property of glycol. It absorbs moisture from the environment.
- Leaving the cap off the glycol container causes the concentration of water to increase. The glycol concentration is then lower and the water could freeze.
- Preventive actions must be taken to ensure minimal exposure of the glycol to air.

Also refer to "10.3 Pre-operation checks/Checks before initial start-up"

9.4 Filling with water

1. Connect the water supply to the fill valve and open the valve.
2. Make sure the automatic air purge valve is open (at least 2 turns).
3. Fill with water until the manometer indicates a pressure of approximately 2.0 bar. Remove air in the circuit as much as possible using the air purge valves. Air present in the water circuit might cause malfunctioning of the backup heater.

Do not fasten the black plastic cover on the vent valve at the top side of the unit when the system is running. Open air purge valve, turn anticlockwise at least 2 full turns to release air from the system.

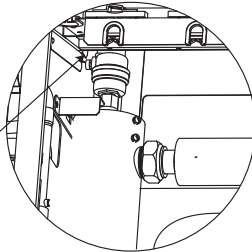

NOTE

During filling, it might not be possible to remove all air in the system. Remaining air will be removed through the automatic air purge valves during the first operating hours of the system. Topping up the water afterwards might be required.

- The water pressure indicated on the manometer will vary depending on the water temperature (higher pressure at higher water temperature). However, at all times water pressure should remain above 0.3 bar to avoid air entering the circuit.
- The unit might drain-off too much water through the pressure relief valve.
- Water quality must be according to "Safe Drinking water Act"

9.5 Piping insulation

The complete water circuit including all piping, must be insulated to prevent condensation during cooling operation and reduction of the heating and cooling capacity as well as prevention of freezing of the outside water piping during winter. The thickness of the sealing materials must be at least 13 mm with $\lambda = 0.039 \text{ W/mK}$ in order to prevent freezing on the outside water piping.

If the temperature is higher than 30°C and the humidity is higher than RH 80%, then the thickness of the sealing materials should be at least 20 mm in order to avoid condensation on the surface of the seal.

9.6 Field wiring



WARNING

- A main switch or other means of disconnection, having a contact separation in all poles, must be incorporated in the fixed wiring in accordance with relevant local laws and regulations.
- Switch off the power supply before making any connections.
- Use only copper wires.
- Never squeeze bundled cables and make sure they do not come in contact with the piping and sharp edges. Make sure no external pressure is applied to the terminal connections.
- All field wiring and components must be installed by a licensed electrician and must comply with relevant local laws and regulations.
- The field wiring must be carried out in accordance with the wiring diagram supplied with the unit and the instructions given below.
- Be sure to use a dedicated power supply. Never use a power supply shared by another appliance.
- Be sure to establish a ground. Do not ground the unit to a utility pipe, surge protector, or telephone ground. Incomplete grounding may cause electrical shock.
- Be sure to install a ground fault circuit interrupter (30 mA). Failure to do so may cause electrical shock.
- Be sure to install the required fuses or circuit breakers.

9.6.1 Precautions on electrical wiring work

- Fix cables so that cables do not make contact with the pipes (especially on the high pressure side).
- Secure the electrical wiring with cable ties as shown in figure so that it does not come in contact with the piping, particularly on the high-pressure side.
- Make sure no external pressure is applied to the terminal connectors.
- When installing the ground fault circuit interrupter make sure that it is compatible with the inverter (resistant to high frequency electrical noise) to avoid unnecessary opening of the ground fault circuit interrupter.



NOTE

The ground fault circuit interrupter must be a high-speed type breaker of 30 mA (<0.1 s).

- This unit is equipped with an inverter. Installing a phase advancing capacitor not only will reduce the power factor improvement effect, but also may cause abnormal heating of the capacitor due to high-frequency waves. Never install a phase advancing capacitor as it could lead to an accident.

9.6.2 Overview

The illustration below gives an overview of the required field wiring between several parts of the installation. Refer also to "8 Typical application examples".

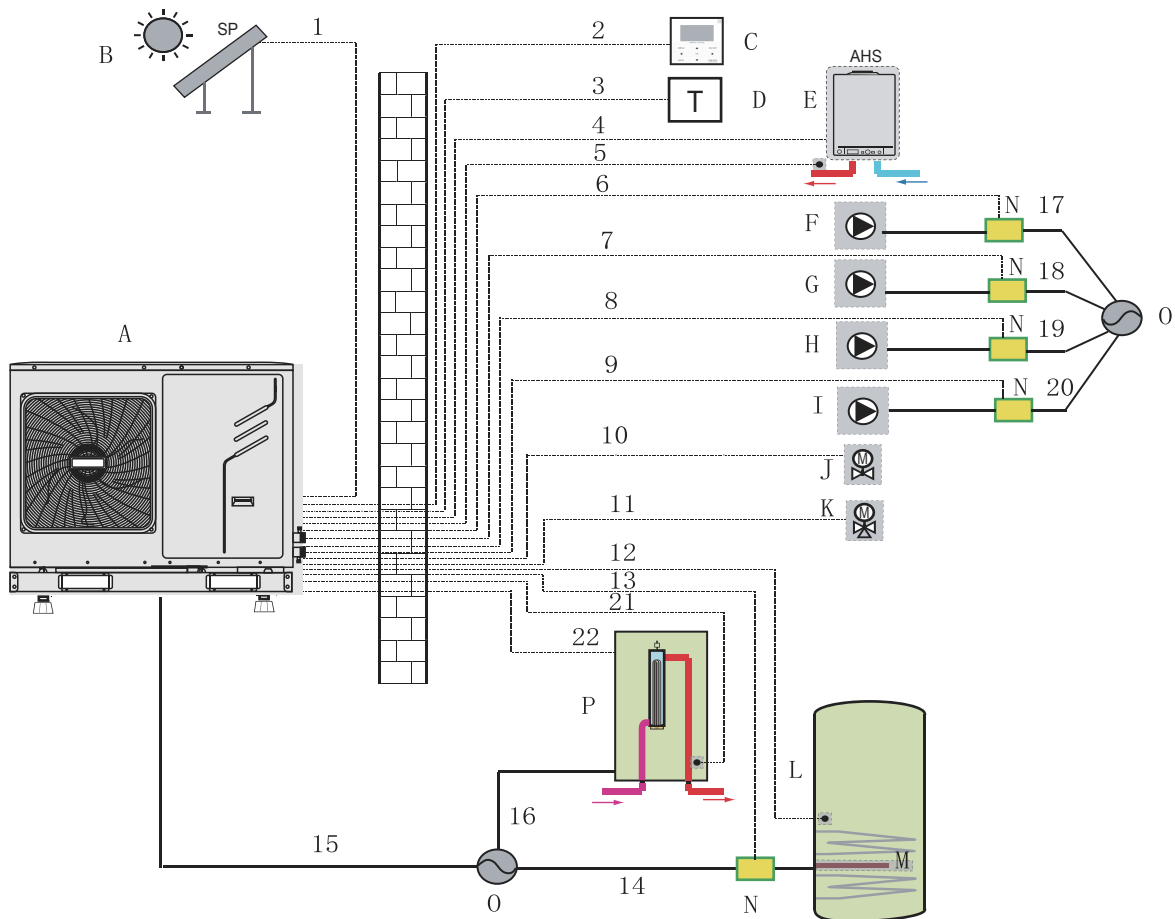
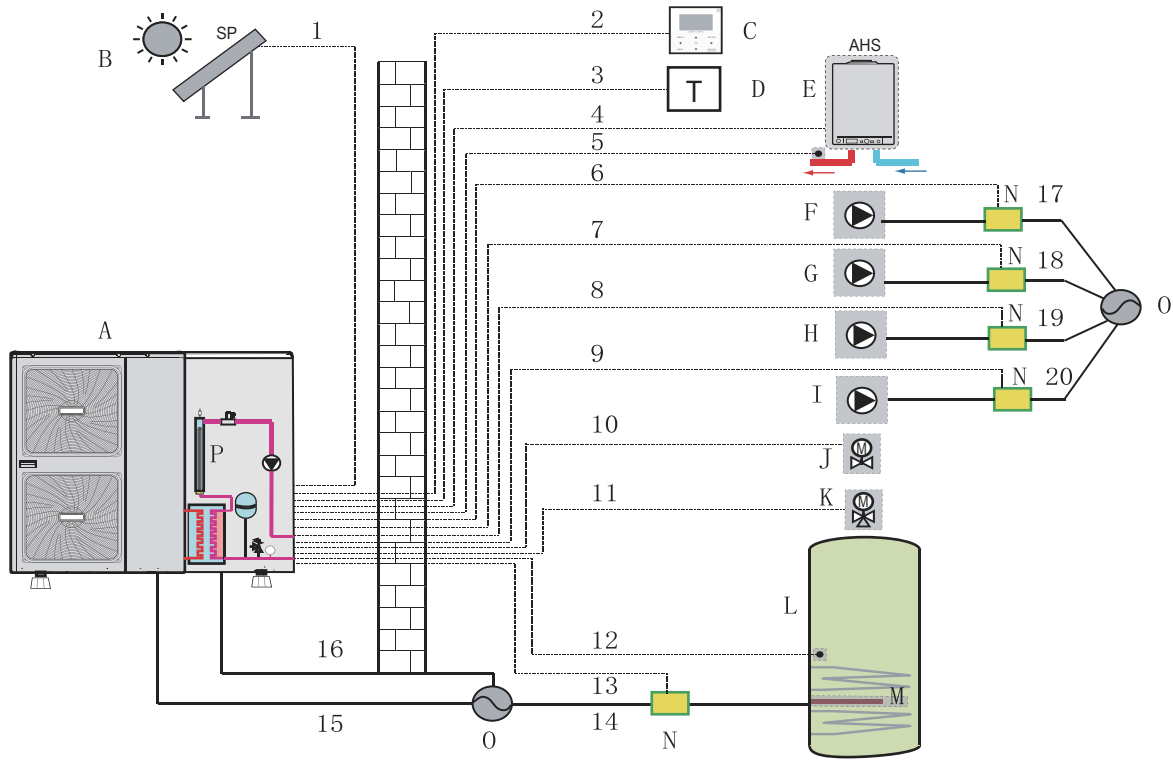

- A Outdoor unit
- B Solar energy kit (field supply)
- C User interface
- D Room thermostat (field supply)
- E Boiler (field supply)
- F P_s: Solar pump (field supply)

- G P_c: Mixing pump (field supply)
- H P_o: Outside circulation pump (field supply)
- I P_d: DHW pump (field supply)
- J SV2: 2-way valve (field supply)
- K SV1: 3-way valve for domestic hot water tank (field supply)

- L Domestic hot water tank
- M Booster heater
- N Contactor
- O Power supply
- P Backup heater

Item	Description	AC/DC	Required number of conductors	Maximum running current
1	Solar energy kit signal cable	AC	2	200mA
2	User interface cable	AC	5	200mA
3	Room thermostat cable	AC	2 or 3	200mA(a)
4	Boiler control cable	/	2	200mA
5	Thermistor cable for T1B	DC	2	(b)
9	DHW pump control cable	AC	2	200mA(a)
10	2-way valve control cable	AC	2	200mA(a)
11	3-way valve control cable	AC	2 or 3	200mA(a)
12	Thermistor cable	DC	2	(b)
13	Booster heater control cable	AC	2	200mA(a)
15	Power supply cable for unit	AC	2+GND (1-phase) 3+GND (3-phase)	31A (1-phase) 15A (3-phase)
16	Power supply cable for backup heater	AC	2+GND (1-phase) 3+GND (3-phase)	14A (1-phase) 6A (3-phase)

(a) Minimum cable section AWG18 (0.75 mm²)

(b) The thermistor cable are delivered with the unit

*: if the current of the load is large, an AC contactor is needed.

NOTE:Please use H07RN-F for the power wire, all the cable are connect to high voltage except for thermistor cable and cable for user interface.

- 1.Equipment must be grounded.
- 2.All high-voltage external load, if it is metal or a grounded port, must be grounded.
- 3.All external load current is needed less than 0.2A, if the single load current is greater than 0.2A, the load must be controlled through AC contactor.
- 4.AHS1" "AHS2", "A1" "A2", "R1" "R1" and "DTF1" "DTF2" wiring terminal ports provide only the switch signal.
- 5.Expansion valve E-Heating tape,Plate heat exchanger E-Heating tape and Flow switch E-Heating tape share a control port.
- 6.WIRING: transfer board/13 to 40 connection priority

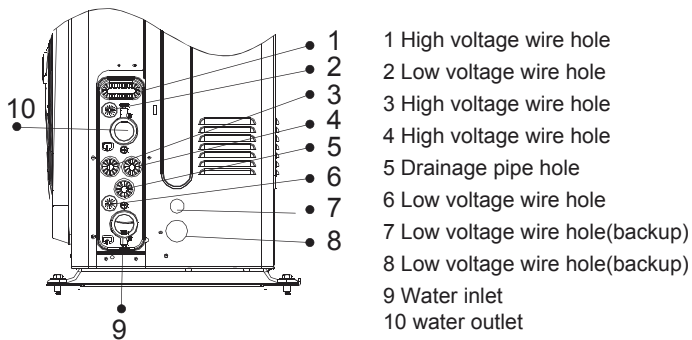

1-phase 10~16kW
3-phase 12~16kW

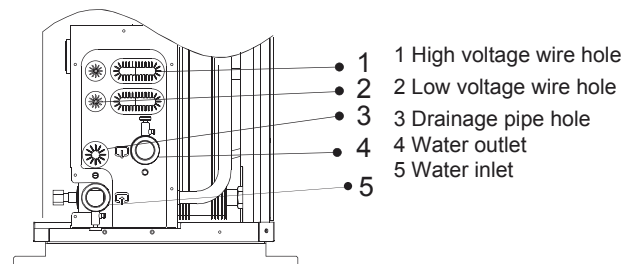

1-phase 5/7/9 kW

Field wiring guidelines

- Most field wiring on the unit is to be made on the terminal block inside the switch box. To gain access to the terminal block, remove the switch box service panel (door 2).



WARNING

Switch off all power including the unit power supply and backup heater and domestic hot water tank power supply (if applicable) before removing the switch box service panel.

- Fix all cables using cable ties.
- A dedicated power circuit is required for the backup heater.
- Installations equipped with a domestic hot water tank (optional) require a dedicated power circuit for the booster heater. Please refer to the domestic hot water tank Installation & Owner's Manual. *Secure the wiring in the order shown below.*
- Lay out the electrical wiring so that the front cover does not rise up when doing wiring work and attach the front cover securely (see figure).
- Follow the electric wiring diagram for electrical wiring works (the electric wiring diagrams are located on the rear side of door 2).
- Install the wires and fix the cover firmly so that the cover may be fit in properly.

9.6.3 Precautions on wiring of power supply

- Use a round crimp-style terminal for connection to the power supply terminal board. In case it cannot be used due to unavoidable reasons, be sure to observe the following instructions.

- Do not connect different gauge wires to the same power supply terminal. (Loose connections may cause overheating.)
- When connecting wires of the same gauge, connect them according to the figure below.



- Use the correct screwdriver to tighten the terminal screws. Small screwdrivers can damage the screw head and prevent appropriate tightening.
- Over-tightening the terminal screws can damage the screws.
- Attach a ground fault circuit interrupter and fuse to the power supply line.
- In wiring, make certain that prescribed wires are used, carry out complete connections, and fix the wires so that outside force cannot affect the terminals.

9.6.4 Specifications of standard wiring components

Door 1: compressor compartment and electrical parts: XT1

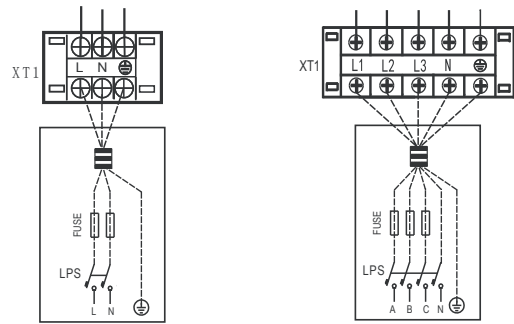

OUTDOOR UNIT POWER SUPPLY
1-phase

OUTDOOR UNIT POWER SUPPLY
3-phase

	1-phase 5/7/9 kW	1-phase 10~16kW	3-phase 12~16kW
Maximum overcurrent protector(MOP)	25	40	20
Wiring size	4 mm ²	6 mm ²	4 mm ²

(a) Stated values are maximum values (see electrical data for exact values).



NOTE

The ground fault circuit interrupter must be a high-speed type breaker of 30 mA (<0.1 s).

9.6.5 Connection of the backup heater power supply

Power circuit and cable requirements



- Be sure to use a dedicated power circuit for the backup heater. Never use a power circuit shared by another appliance.
- Use the same dedicated power supply for the unit, backup heater and booster heater (domestic hot water tank).

This power circuit must be protected with the required safety devices according to local laws and regulations. Select the power cable in accordance with relevant local laws and regulations. For the maximum running current of the backup heater, refer to the table below.

	Backup heater capacity	
	3kW 1-phase	4.5kW 3-phase
Backup heater nominal voltage	220-240VAC	380-415VAC
Minimum circuit amps (MCA)	14.3	6
Maximum overcurrent protector (MOP)	20	10
Wiring size	3.3mm ²	2.1mm ²

Door 2: electrical parts of the hydraulic compartment, backup heater:XT5 (3-phase) /XT4(1-phase)

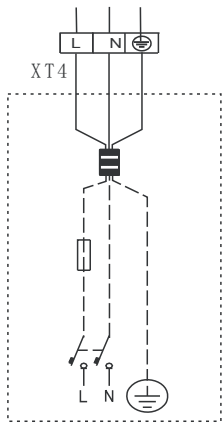

POWER SUPPLY FOR ELECTRIC HEATER

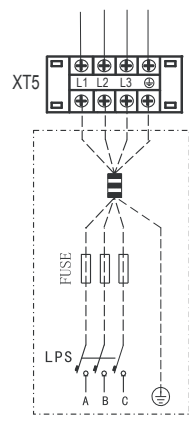

POWER SUPPLY FOR ELECTRIC HEATER



NOTE

The ground fault circuit interrupter must be a high-speed type breaker of 30 mA (<0.1 s).

9.6.6 Connection for other components

Port provide the control signal to the load. Two kind of control signal port:

Type 1: dry connector without voltage.

Type 2: Port provide the signal with 220V voltage. If the current of load is <0.2A, load can connect to the port directly.

If the current of load is $\geq 0.2A$, the AC connector is required to be connected for the load.

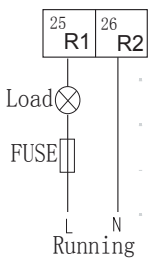

Type 1

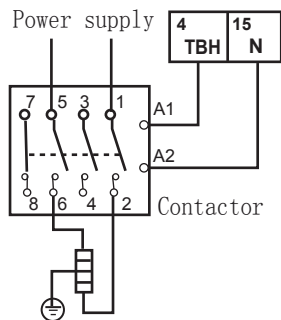

Type 2

Control signal port of hydraulic part : The XT7 contains terminals for solar energy, remote alarm, 2-way valve, 3-way valve, pump, booster heater and external heating source, etc.

The parts wiring is illustrated below:

For solar energy kit

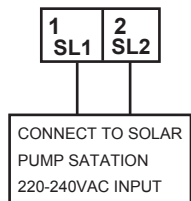

Voltage	220-240VAC
Maximum running current	0.2A
Wiring size	0.75mm ²

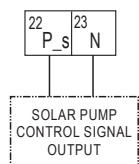

Voltage	220~240VAC
Maximum running current	0.2A
Wiring size	0.75mm ²
Control port signal type	Type 2

For remote alarm:

REMOTE ALARM

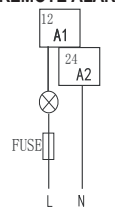

REMOTE ALARM

Voltage	Passive signal port
Maximum running current	0.2A
Wiring size	0.75mm ²
Control port signal type	Type 1

Procedure

1. Connect the cable to the appropriate terminals as shown on the diagram.
2. Fix the cable with cable ties to the cable tie mountings to ensure stress relief.

For 2-way valve SV2:

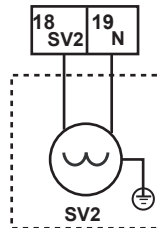

Voltage	220~240VAC
Maximum running current	0.2A
Wiring size	0.75mm ²
Control port signal type	Type 2

NOTE: Only a normal closing valve is available for this unit

Procedures

1. Connect the valve cable to the appropriate terminals as shown in the picture
2. Fix the cable with cable ties to the cable tie mountings to ensure stress relief

For 3-way value SV1

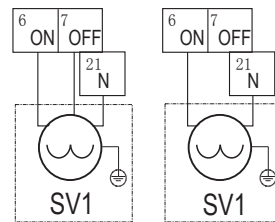

Method 1

Method 2

NOTE: Wiring of the 3-way valve is different for NC(normal close) and NO (normal open). Before wiring, read the Installation & Owner's manual for the 3-way valve carefully and install the valve as showed in the picture. Make sure to connect it to the correct terminal numbers.

Voltage	220~240VAC
Maximum running current	0.2A
Wiring size	0.75mm ²
Control port signal type	Type 2

Procedure

1. Connect the cable to the appropriate terminals as shown in the picture
2. Fix the cable with cable ties to the cable tie mountings to ensure stress relief.

For remote shutdown:

SWITCH SIGNAL INPUT

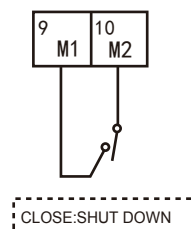

For tank loop pump P_d and mix pump P_c:

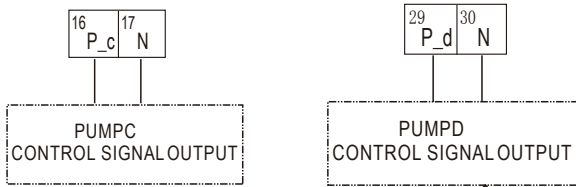

Voltage	220~240VAC
Maximum running current	0.2A
Wiring size	0.75mm ²
Control port signal type	Type 2

NOTE
For 5/7/9 kW unit, the terminal number is 37 and 38.

Procedure

1. Connect the cable to the appropriate terminals as shown in the picture.
2. Fix the cable with cable ties to the cable tie mountings to ensure stress relief

For room thermostat:

External ON/OFF thermostat

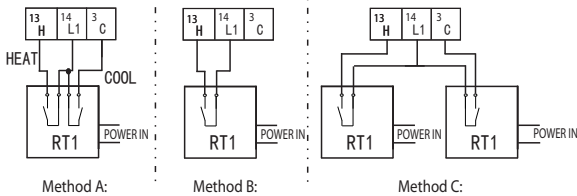

External thermostat

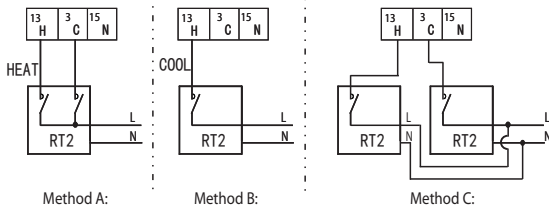

Voltage	220-240VAC
Maximum running current	0.2A
Wiring size	0.75mm ²

Note:

there are two optional connect method depend on the room thermostat type.

1. Room thermostat type 1(RT1): "POWER IN" provide the working voltage to the RT, doesn't provide the voltage to the RT connector directly. Port "14 L1" provide the 220V voltage to the RT connector. Port "14 L1" connect from the unit main power supply port L of 1-phase power supply, L2 port of 3-phase power supply.
2. Room thermostat type 2(RT2)(Recommend wire connection method): L N provide the power supply to the RT connector directly. L connect from the unit main power supply port L of 1-phase power supply, L2 of 3-phase power supply.

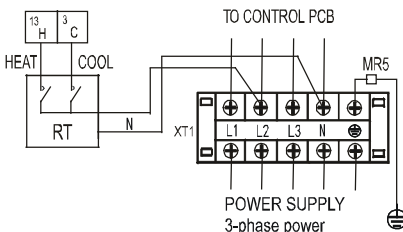

There are three methods for connecting the thermostat cable (as described in the picture above) and it depends on the application.

Method A

RT can control heating and cooling individually, like the controller for 4-pipe FCU. When the hydraulic module is connected with the external temperature controller, user interface FOR SERVICEMAN set THERMOSTAT and ROOM MODE SETTING to YES:

- A.1 When unit detect voltage is 230VAC between C and N, the unit operates in the cooling mode
- A.2 When unit detect voltage is 230VAC between H and N, the unit operates in the heating mode.
- A.3 When unit detect voltage is 0VAC for both side(L-N, H-N) the unit stop working for space heating or cooling.
- A.4 When unit detect voltage is 230VAC for both side(L-N, H-N) the unit working in cooling mode.

Method B

RT provide the switch signal to unit. user interface FOR SERVICEMAN set ROOM THERMOSTAT and MODE SETTING to YES:

- B.1 When unit detect voltage is 230VAC between H and N, unit turn on.
 - B.2 When unit detect voltage is 0VAC between H and N, unit turn off.
- Note: When ROOM THERMOSTAT is set to YES, the indoor temperature sensor Ta can't be set to valid, unit running only according to T1.

Method C

Hydraulic module is connected with two external temperature controllers, while user interface FOR SERVICEMAN set DUAL ROOM THERMOSTAT to YES,

- C.1 When unit detect voltage is 230VAC between H and N, the MAIN side turn on. When unit detect voltage is 0VAC between H and N, the MAIN side turn off.
- C.2 When unit detect voltage is 230VAC between C and N, the ROOM side turn on according to climate temp curve. When unit detect voltage is 0V between C and N, the ROOM side turn off.
- C.3 When H-N and C-N are detected as 0VAC, unit turn off.
- C.4 when H-N and C-N are detected as 230VAC, both MAIN and ROOM side turn on.

NOTE:

1. The wiring of the thermostat should correspond to the settings of the user interface. Refer to **10.7 Field setting/Room Thermostat.**
2. Power supply of machine and room thermostat must be connected to the same Neutral Line and (L2) Phase Line(for 3-phase unit only).

Procedure

1. Connect the cable to the appropriate terminals as shown on the picture
2. Fix the cable with cable ties to the cable tie mountings to ensure stress relief

For booster heater:

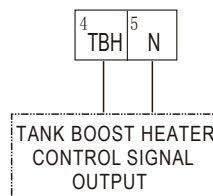

Voltage	220~240VAC
Maximum running current	0.2A
Wiring size	0.75mm ²
Control port signal type	Type 2

Connection of the booster heater cable depends on the application. Only when the domestic hot water tank is installed will this wiring be needed. The unit only sends a turn on/off signal to the booster heater. An additional circuit breaker is needed and a dedicated terminal is needed to supply power to the booster heater.

See also **"8 Typical application examples"** and **"10.7 Field settings/DHW control"** for more information.

Procedure

1. Connect the cable to the appropriate terminals as shown on the picture
2. Fix the cable with cable ties to the cable tie mountings to ensure strain relief

For boiler and outside circulation pump P_o:

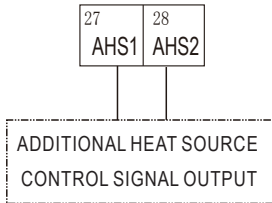

NOTE	
For 5/7/9 kW unit, the terminal number is 25 and 26.	

Voltage	220~240VAC
Maximum running current	0.2A
Wiring size	0.75mm ²
Control port signal type	Type 2

For outside circulation pump P_o:

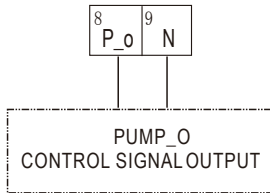

Voltage	220~240VAC
Maximum running current	0.2A
Wiring size	0.75mm ²
Control port signal type	Type 2

Procedure

1. Connect the cable to the appropriate terminals as shown on the picture
2. Fix the cable with cable ties to the cable tie mountings to ensure stress relief.

For feedback switch signal input (5/7/9 kW unit only, reserved) :

IBH1/2 FEEDBACK INPUT
(SWITCH SIGNAL INPUT)

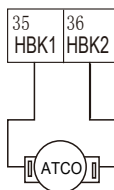

Atco:auto reset thermal protector
It must be connected to thermal protector!

For external backup heater box(5/7/9 kW unit only)

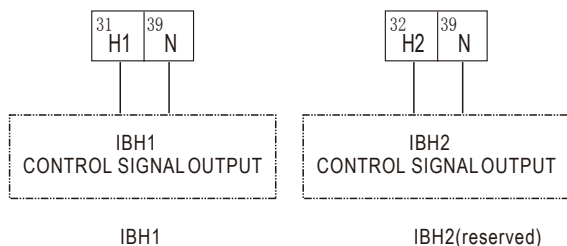

For defrosting signal output:

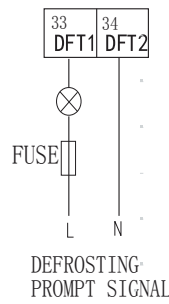

Voltage	220~240VAC
Maximum running current	0.2A
Wiring size	0.75mm ²
Control port signal type	Type 1

For user interface:

COMMUNICATION

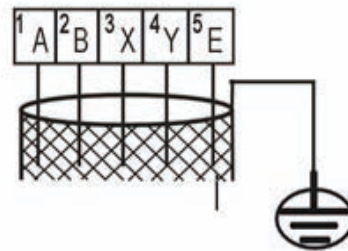
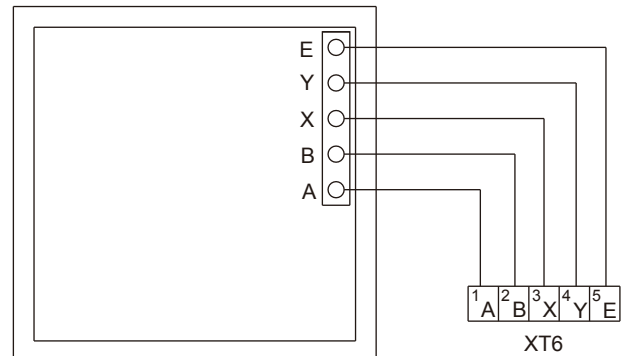

“PLEASE USE SHIELDED WIRE AND EARTH THE WIRE.”



NOTE

This equipment supports MODBUS RTU communication protocol.

Wire type	5 wire shielded cable
Wire section	AWG18-AWG16(0.75~1.25mm ²)
Maximum wire length	50m

As described above, during wiring, port A in the unit terminal XT6 corresponds to port A in the user interface. Port B corresponds to port B. Port X corresponds to port X. Port Y corresponds to port Y, and port E corresponds to port E..

Procedure

1. Remove the rear part of the user interface.
2. Connect the cable to the appropriate terminals as shown in the picture
3. Reattach the rear part of the user interface

10 START-UP AND CONFIGURATION

The unit should be configured by the installer to match the installation environment (outdoor climate, installed options, etc.) and user expertise.



It is important that all information in this chapter is read sequentially by the installer and that the system is configured as applicable.

10.1 Climate related curves

The climate related curves can be selected in the user interface, the curves for heating mode and ECO heating mode are the same but the default curve is curve 4 in heating mode, while in ECO mode, the default curve is curve 6 (refer to the operation manual, **6.2.2 Weather Temperature set**, if ECO mode is enabled, please refer to the operation manual **6.2.3 ECO Mode**). Once the curve is selected, the target outlet water temperature is determined by the outdoor temperature. In each mode, you can select one curve from eight curves in the user interface (curve can't be selected if dual room thermostat function is enabled, but for customization it's possible to select curves even dual room thermostat function is enabled). The relationship between outdoor temperature (T4/°C) and target water temperature (T1s/°C) is described in the table and picture in the next page.

The selection of the low/high temperature curve can be done in the user interface. In cool mode refer to **10.7 Field setting/COOL control/How to set the COOL mode**. In heat mode refer to **10.7 Field setting/HEAT control/How to set the HEAT mode**.

Note: if dual room thermostat function is enabled, only curve 4 can be used, for customization product, curve selection is possible even dual room thermostat function is enabled.

Temperature curves for heating mode and ECO heating mode

Application	T1s Curve number	Outdoor Temperatures T4										
		-20	-15	-10	-5	0	5	10	15	20	25	35
Low temperature	1	38	37	36	36	35	34	33	33	32	32	32
	2	35	34	34	33	32	32	31	31	30	30	30
	3	33	33	32	32	31	31	31	30	30	30	30
	4	35	34	33	32	31	31	30	29	28	28	28
	5	33	32	32	31	30	30	29	29	28	28	28
	6	31	30	30	29	28	28	27	27	26	26	26
	7	29	29	28	28	27	27	27	26	26	26	26
	8	29	28	28	27	26	26	25	25	24	24	24
High temperature	1	55	54	54	53	52	52	51	51	50	50	50
	2	55	54	52	51	50	49	47	46	45	45	45
	3	55	53	51	49	47	45	44	42	40	40	40
	4	50	49	49	48	47	47	46	46	45	45	45
	5	50	49	47	46	45	44	42	41	40	40	40
	6	45	44	44	43	42	42	41	41	40	40	40
	7	45	44	42	41	40	39	37	36	35	35	35
	8	40	39	39	38	37	37	36	36	35	35	35

Temperature curves for Cooling mode

Application	T1s Curve number	Outdoor Temperatures T4			
		-5~14	15~21	22~29	30~46
Low temperature	1	18	11	8	5
	2	17	12	9	6
	3	18	13	10	7
	4	19	14	11	8
	5	20	15	12	9
	6	21	16	13	10
	7	22	17	14	11
	8	23	18	15	12
High temperature	1	22	20	18	16
	2	20	19	18	17
	3	23	21	19	17
	4	21	20	19	18
	5	24	22	20	18
	6	22	21	20	19
	7	25	23	21	19
	8	23	22	21	20

Low temperature curves for heating mode

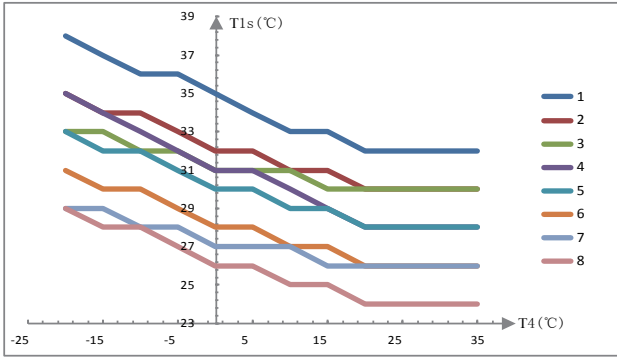

High temperature curves for heating mode

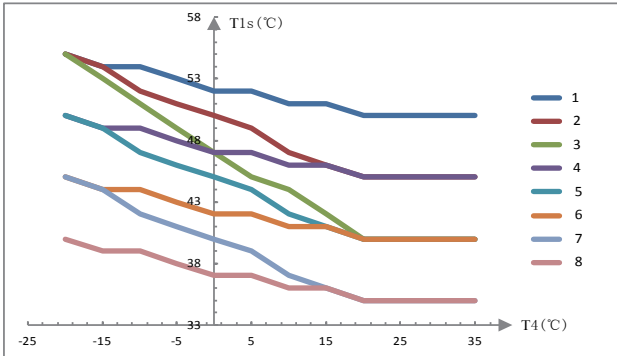

Low temperature curves for cooling mode

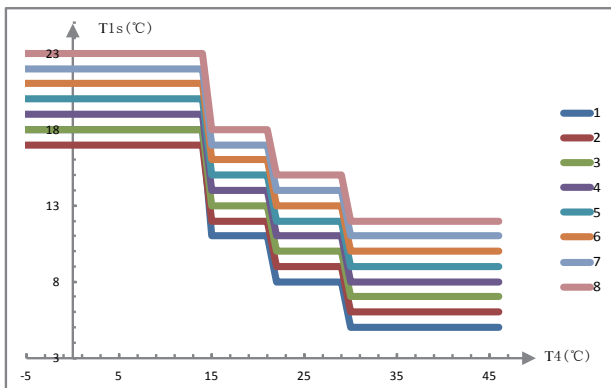

High temperature curves for cooling mode

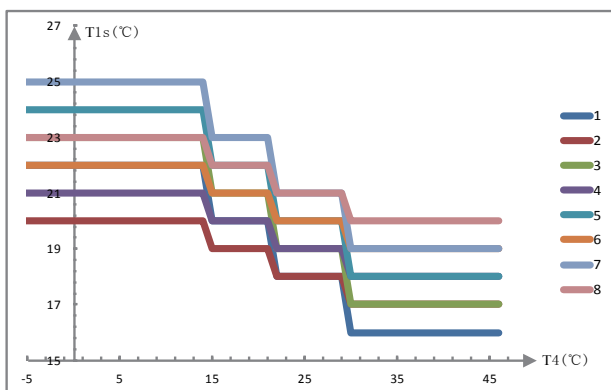

10.2 DIP switch settings overview

DIP switch 13 is located on the hydraulic module main control board (see "9.2.3 main control board of hydraulic module") and allows configuration of additional heating source thermistor installation, the second inner backup heater installation, etc.



WARNING

Switch off the power supply before opening the switch box service panel and making any changes to the DIP switch settings.

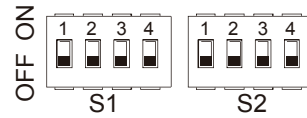

DIP switch	Description	ON	OFF
S1	1 Selection of refrigerant pipe length	50m	5m
	2 Backup heater outlet temperature thermistor installation	Installed	Installed
	3 The first inner backup heater installation	Not installed	Installed
	4 The second inner backup heater installation	Not installed	Installed
S2	1 Additional heating source outlet temperature thermistor installation	Installed	Not installed
	2 /	/	/
	3 /	/	/
	4 /	/	/

10.3 Initial start-up at low outdoor ambient temperatures

During initial start-up and when water temperature is low, it is important that the water is heated gradually. Failure to do so may result in concrete floors cracking due to rapid temperature change. Please contact the responsible cast concrete building contractor for further details.

To do so, the lowest water flow set temperature can be decreased to a value between 25°C and 35°C by adjusting the FOR SERVICEMAN. Refer to "FOR SERVICEMAN/special function/preheating for floor".

10.4 Pre-operation checks

Checks before initial start-up

DANGER



Switch off the power supply before making any connections.

After the installation of the unit, check the following before switching on the circuit breaker:

1. Field wiring
Make sure that the field wiring between the local supply panel and unit and valves (when applicable), unit and room thermostat (when applicable), unit and domestic hot water tank, and unit and backup heater box have been connected according to the instructions described in the chapter **9.6 Field wiring**, according to the wiring diagrams and to local laws and regulations.
2. Fuses, circuit breakers, or protection devices
Check that the fuses or the locally installed protection devices are of the size and type specified in the chapter **14 Technical specifications**. Make sure that no fuses or protection devices have been bypassed.
3. Backup heater circuit breaker
Do not forget to turn on the backup heater circuit breaker in the switchbox (it depends on the backup heater type). Refer to the wiring diagram.
4. Booster heater circuit breaker
Do not forget to turn on the booster heater circuit breaker (applies only to units with optional domestic hot water tank installed).
5. Ground wiring
Make sure that the ground wires have been connected properly and that the ground terminals are tightened.
6. Internal wiring
Visually check the switch box for loose connections or damaged electrical components.
7. Mounting
Check that the unit is properly mounted, to avoid abnormal noises and vibrations when starting up the unit.
8. Damaged equipment
Check the inside of the unit for damaged components or squeezed pipes.
9. Refrigerant leak
Check the inside of the unit for refrigerant leakage. If there is a refrigerant leak, call your local dealer.
10. Power supply voltage
Check the power supply voltage on the local supply panel. The voltage must correspond to the voltage on the identification label of the unit.
11. Air purge valve
Make sure the air purge valve is open (at least 2 turns).
12. Shut-off valves
Make sure that the shut-off valves are fully open



Operating the system with closed valves will damage the circulation pump!

10.5 Powering up the unit

When power to the unit is turned on, "1%~99%" is displayed on the user interface during initialization. During this process the user interface cannot be operated.

10.6 Setting the pump speed

The pump speed can be selected by adjusting the red knob on the pump. The notch point indicates pump speed.



The default setting is the highest speed (III). If the water flow in the system is too high the speed can be set to low (I).

The available external static pressure function for water flow is shown in the graph below.

**available external static pressure VS flowrate
(5/7/9kW)**

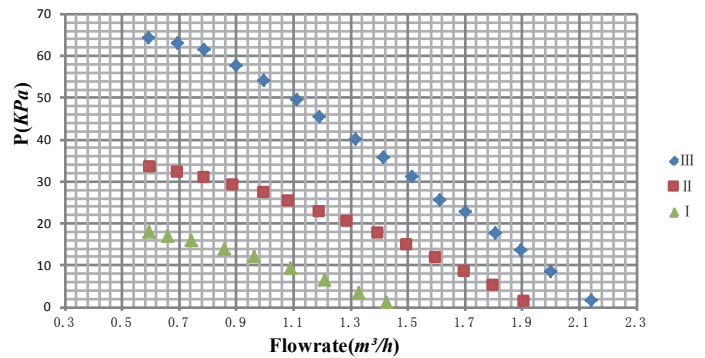

**available external static pressure VS flowrate
(1-phase 10-16kW + 3-phase 12~16kW)**

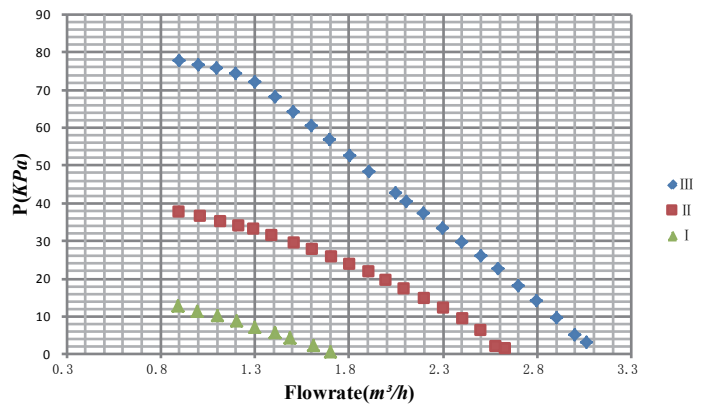

Pump LED diagnosis and solutions

The pump has an LED operating status display. This makes it easy for the technician to search for the cause of a fault in the heating system.

1. If the LED display lights up continuously green, it means the pump is running normally.
2. If the LED display is flashing green, it means the pump is running the venting function. The pump runs during the 10 minute venting function. After its cycle, the installer needs to adjust the targeted performance.
3. If the LED is flashing green/red, it means that the pump has stopped operating due to an external reason. The pump will restart by itself after the abnormal situation disappears. The probable reason causing the problem is pump undervoltage or overvoltage (U<160V or U>280V), and you should check the voltage supply. Another reason is module overheating, and you should check the water and ambient temperatures.
4. If the LED is flashing red, it means the pump has stopped operating, and a serious fault has happened (e.g. pump blocked). The pump cannot restart itself due to a permanent failure and the pump should be changed.
5. If the LED does not light up, it means no power supply to the pump, possibly the pump is not connected to power supply. Check the cable connection. If the pump is still running, it means the LED is damaged. Or the electronics are damaged and the pump should be changed.

Failure diagnosis at the moment of first installation

- If nothing is displayed on the user interface, it is necessary to check for any of the following abnormalities before diagnosing possible error codes.
 - Disconnection or wiring error (between power supply and unit and between unit and user interface).
 - The fuse on the PCB may have blown.
 - If the user interface shows "E8" or "E0" as an error code, there is a possibility that there is air in the system, or the water level in the system is less than the required minimum.
 - If the error code E2 is displayed on the user interface, check the wiring between the user interface and unit.
- More error code and failure causes can be found in **13.4 Error codes**.

10.7 Field settings

The unit shall be configured by the installer to match the installation environment (outdoor climate, installed options, etc.) and user demand. A number of field settings are available. These settings are accessible and programmable through "FOR SERVICEMAN" in user interface.

Procedure

To change one or more field settings, proceed as follows.



Temperature values displayed on the digital controller (user interface) are in °C

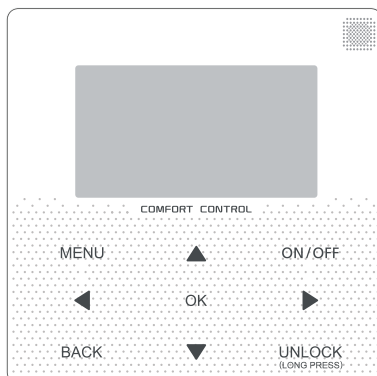

Keys	Function
MENU	• Go to the menu structure (on the home page)
◀▶ ▼ ▲	• Navigate the cursor on the display • Navigate in the menu structure • Adjust settings
ON/OFF	• Turn on/off the space heating/cooling operation mode or DHW mode • Turn on/or off functions in the menu structure
BACK	• Come back to the up level
UNLOCK	• Long press for unlock /lock the controller • Unlock /lock some functions such as "DHW temperature adjusting"
OK	• Go to the next step when programming a schedule in the menu structure; and confirm a selection to enter in the submenu of the menu structure.

About FOR SERVICEMAN

"FOR SERVICEMAN" is designed for the installer to set the parameter.

1. Setting the composition of equipment.
2. Setting the parameter.

How to go to FOR SERVICEMAN

Go to MENU> FOR SERVICEMAN. Press OK

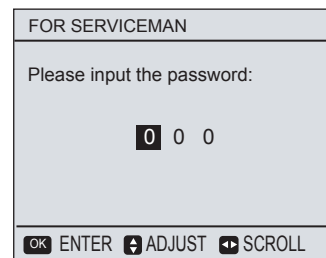

Use ◀ ▶ to navigate and use ▼ ▲ to adjust the numerical value. Press OK. If password is correct, The following page will appear:

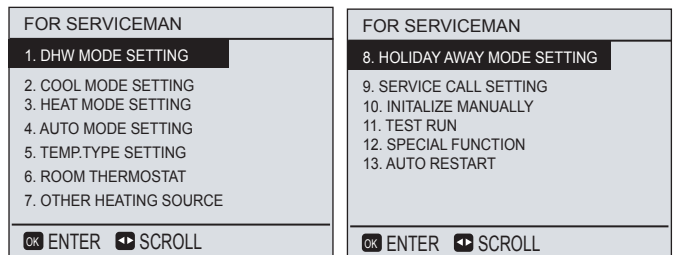

Use ▼ ▲ to scroll and use "ok" to enter submenu for setting the parameters.

DHW control

About DHW mode

DHW: domestic hot water

DHW MODE SETTING typically consists of the following:

1. DHW MODE: enable or disable the DHW mode
2. TANK HEATER: set whether the booster heater is available or not
3. DISINFECT: set the parameters for disinfection
4. DHW PRIORITY: set the priority between domestic hot water heating and space operation
5. DHW PUMP: set the parameters for DHW pump operation. The functions above apply only to installations with a domestic hot water tank.

How to set the DHW mode

To determine whether the DHW mode is effective.

Go to MENU> FOR SERVICEMAN> DHW MODE SETTING. Press OK. The following page is displayed:

1 DHW MODE SETTING	
1.1. DHW MODE	<input checked="" type="checkbox"/> YES <input type="checkbox"/> NON
1.2. TANK HEATER	<input checked="" type="checkbox"/> YES <input type="checkbox"/> NON
1.3. DISINFECT	<input checked="" type="checkbox"/> YES <input type="checkbox"/> NON
1.4. DHW PRIORITY	<input checked="" type="checkbox"/> YES <input type="checkbox"/> NON
1.5. DHW PUMP	<input type="checkbox"/> YES <input checked="" type="checkbox"/> NON
OK ENTER ▶ SCROLL	

Use ◀ ▶ to scroll and OK for enter. When the cursor is on YES, Press OK to set the DHW MODE as effective. When the cursor is on NON,press OK to set the DHW MODE as ineffective.

1. Go to MENU> FOR SERVICEMAN>DHW MODE SETTING>1.1 DHW MODE

1.1 DHW MODE	
dT5_ON	5°C
dT1S5	10°C
T4DHWMAX	43°C
T4DHWMIN	-10°C
t_INTERVAL_DHW	5 MIN
▶ SCROLL	

Use ◀ ▶ and ▼ ▲ to scroll and adjust parameters. Use BACK to exit.

dT5_ON is the temperature difference for starting the heat pump, the picture below illustrates the dT5_ON function.

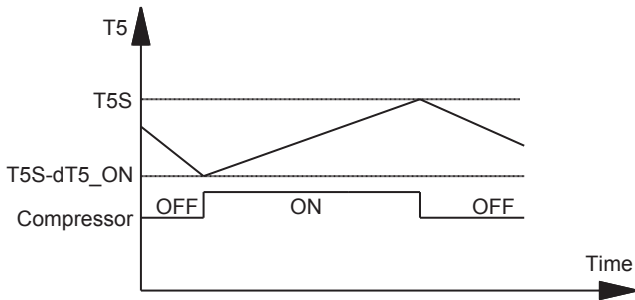

T5S is the target temperature for domestic hot water. T5 is the actual temperature of domestic hot water. When T5 drops to a certain temperature ($T5 < T5S - dT5_{ON}$) the heat pump will be available. dT1S5 is the correct value for the target outlet water temperature ($T1S = T5 + dT1S5$).

Note: the default value of dT1S5 is 10, if surface area of coil in tank is not large enough, heat pump will stop even water temperature in the tank is far below the setpoint, it is suggested that set dT1S5 to 20. If water temperature probe located in the bottom of tank, it is possible that long time is needed to turn on the heat pump, in this condition please set dT1s5 to 20 and put the temperature probe to the upper part of the tank.

T4DHWMAX is the maximum ambient temperature that the heat pump can operate at for domestic water heating. The unit will not operate if the ambient temperature goes above it in DHW mode.

T4DHWMIN is the minimum ambient temperature that the heat pump can operate for domestic water heating. The heat pump will turn off if the ambient temperature drops below it in water heating mode. The relationship between operation of the unit and ambient temperature can be illustrated in the picture below:

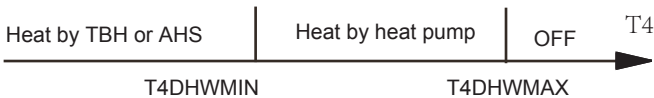

T_INTERVAL_DHW is the start time interval of the compressor in DHW mode. When the compressor stops running, the next time the compressor turns on it should be T_INTERVAL_DHW plus one minute later at least.

2 If tank heater (booster heater) is available, Go to FOR SERVICEMAN >DHW MODE SETTING>1.2 TANK HEATER and select "Yes", when "OK" pressed, the following page will appear:

1.2 TANK HEATER	
dT5_TBH_OFF	5°C
T4_TBH_ON	20°C
t_TBH_DELAY	30 MIN
▶ SCROLL	

Use ◀ ▶ and ▼ ▲ to scroll and adjust parameters. Use BACK to exit.

dT5_TBH_OFF is the temperature difference between T5 and T5S that turns the booster heater off. The booster heater will turn off ($T5 \geq T5S + dT_{TBH_OFF}$) when the heat pump malfunctions.

T4_TBH_ON is the temperature only when the ambient temperature is lower than its parameter and the booster heater will be available. t_TBH_DELAY is the time that the compressor has run before starting the booster heater (if $T5 < \min(T5S, T5stop)$). The operation of the unit during DHW mode described in the picture below:

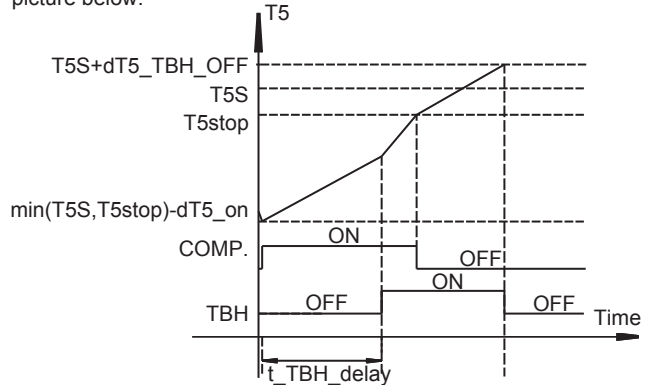

In the picture, T5stop is a parameter related to ambient temperature, which cannot be changed in the user interface. When $T5 \geq T5stop$, the heat pump will turn off.

Note: the booster heater and backup heater can't operate simultaneously, if the booster heater has been on, the backup heater will be off.

If the booster heater is unavailable (1.2 TANK HEATER NON is selected), the dT5_ON cannot be adjusted and is fixed at 4.

3. To enable disinfect function, Go to MENU> FOR SERVICEMAN> DHW MODE SETTING>1.3 DISINFECT and select "YES", when "OK" pressed, the following page will appear.

1.3 DISINFECT	
T5S_DI	65°C
t_DI_HIGHTMEP.	30 MIN
t_DI_MAX	120 MIN
▶ SCROLL	

T5S_DI is the target temperature of water in the domestic hot water tank in the DISINFECT function.

t_DI_HIGHTEMP is the time that the hot water will last.

t_DI_MAX is the time that disinfection will last. The change of domestic water temperature is described in the picture below:

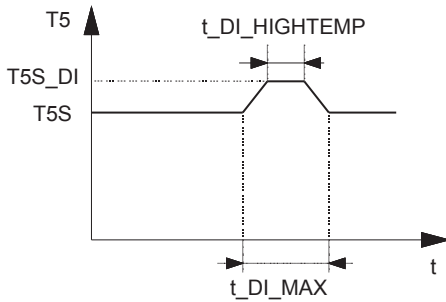

Be aware that the domestic hot water temperature at the hot water tap will be equal to the value selected in FOR SERVICEMAN "T5S_DI" after a disinfection operation.

Note: if booster heater is not available (refer to **10.7 Field settings/Other heating source**), please disable DISINFECT, because the temperature of water from heat pump is not high enough, and the unit will stay in Disinfect mode for a long time, which will effect space heating.



WARNING

If this high domestic hot water temperature can be a potential risk for human injuries, a mixing valve (field supply) should be installed at the hot water outlet connection of the domestic hot water tank. This mixing valve will ensure that the hot water temperature at the hot water tap never rises above a set maximum value. This maximum allowable hot water temperature shall be selected according to local laws and regulations.

4. To set the priority between domestic water heating and space operation Go to SERVICEMAN>DHW MODE SETTING>1.4DHW PRIORITY:

1.4 DHW PRIORITY	
t_DHWHP_MAX	120MIN
t_DHWHP_RESTRICT	30MIN
ON/OFF SCROLL	

The function of the DHW PRIORITY is used to set the operation priority between domestic water heating and space (heating/cooling) operation. You can use ◀ ▶ and ▼ ▲ to scroll and adjust parameters. Using BACK to exit.

t_DHWHP_MAX is the maximum continuous working period of the heat pump in DHW PRIORITY mode.

t_DHWHP_RESTRICT is the operation time for the space heating/cooling operation.

Note: if ROOM TEMP is enabled (refer to **10.7 Field setting/ TEMP. TYPE SETTING**), it is suggested that set t_DHWHP_RESTRICT to 10min.

The suggested value of t_DHWHP_MAX is listed below:

Unit	volume of tank/L	t_DHWHP_MAX/min
10~16kW	300	90
	250	75
	200	60
5~7kW	200	90
	150	70
	100	50

If DHW PRIORITY is enabled, the operation of the unit is described in the picture below:

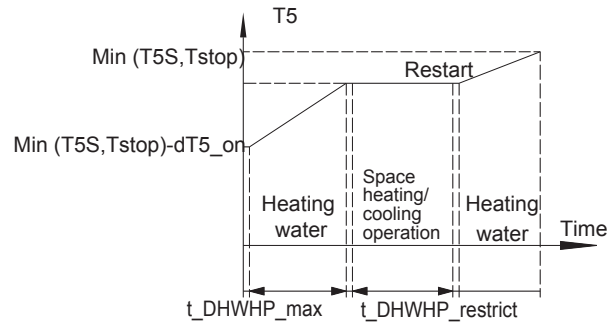

If NON is selected in the DHW PRIORITY mode, when it is available and the space heating/cooling is OFF, the heat pump will heat the domestic water as required. If space heating/cooling is ON, the domestic water will be heated by booster heater (if booster heater is available).

5 If the DHW pump (P_d) is available, Go to FOR SERVICEMAN >DHW MODE SETTING>1.5DHW PUMP and select "YES", when "OK" pressed, the following page will appear, You can use ◀ ▶ and ▼ ▲ to scroll and adjust parameters. Use BACK to exit.

1.5 DHW PUMP	
TIMER RUNNING	ON
DISINFECT	ON
PUMP RUNNING TIME	10MIN
ON/OFF ON/OFF SCROLL	

When the **TIMER RUNNING** is **ON**, the DHW pump will run as timed and keeps running for an certain time (as defined in **PUMP RUNNING TIME**), this can ensure the temperature of water in the system are uniform.

When **DISINFECT** is **ON**, the DHW pump will operate when the unit is in disinfect mode and $T5 \geq T5S_DI - 2$. Pump run time is **PUMP RUNNING TIME**+5min.

COOL MODE SETTING

About COOL MODE SETTING

COOL MODE SETTING typically consists of the following:

1. COOL MODE: Setting the COOL mode effective or non-effective
2. T1S RANGE: Selecting the range of target outlet water temperature
3. T4CMAX: Setting the maximum ambient operation temperature
4. T4CMIN: Setting the minimum ambient operating temperature
5. dT1SC: Setting the temperature difference for starting the heat pump

How to set the COOL mode

To determine whether the COOL mode is effective, go to MENU> FOR SERVICEMAN> COOL MODE SETTING. Press OK. The following page will be displayed:

2 COOL MODE SETTING	
COOL MODE	<input checked="" type="checkbox"/> YES <input type="checkbox"/> NON
T1S RANGE	<input checked="" type="checkbox"/> LOW <input type="checkbox"/> HIGH
T4CMAX	43°C
T4CMIN	20°C
dT1SC	5°C
ON/OFF SCROLL 1/2	

2 COOL MODE SETTING	
dTSC	2°C
t_INTERVAL_C	5MIN
ON/OFF SCROLL 2/2	

When the cursor is on COOL MODE, Use ◀▶ to select YES or NON. Then press OK to enable or disable the cool mode. When the cursor is on T1S RANGE. Use ◀▶ to select the range of outlet water temperature. When **LOW** is selected, the minimum target temperature is 5°C. If climate-related curve function (corresponds to “weather temperature set” in the user interface) is enabled, the curve selected is low temperature curve. When **HIGH** is selected, the minimum target temperature is 18°C, if climate-related curve function (corresponds to “weather temperature set” in the user interface) is enabled, the curve selected is high temperature curve.

When the cursor is on T4CMAX、T4CMIN、dT1SC、dTSC or t_INTERVAL_C, Use ◀▶ and ▼▲ to scroll and adjust the parameter. T4CMAX is the maximum ambient temperature in COOL mode. The unit cannot work if the ambient temperature is higher. T4CMIN is the minimum ambient operating temperature in COOL mode. The unit will turn off if the ambient temperature drops below it. The relationship between the operation of the unit and ambient temperature is shown in the picture below:



dT1SC is the temperature difference between T1 (actual outlet water temperature) and T1S (target outlet water temperature) for starting the unit in cool mode. Only when T1 is high enough will the unit turn on, and will turn off if T1 drops to a certain value. See the diagram below:

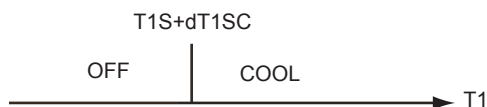

dTSC is the temperature difference between Ta (actual room temperature) and TS (target room temperature) To start the unit when ROOM TEMP is enabled in TEMP.TYPE SETTING (refer to 10.7 Field setting/TEMP.TYPE SETTING). Only when the Ta is high enough will the unit turn on, and the unit will turn off if the Ta drops to a certain value. Only when the ROOM TEMP is enabled will this function be available. See picture below:

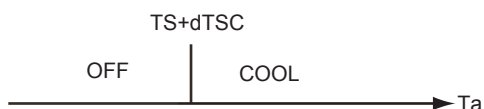

HEAT MODE SETTING

About HEAT MODE SETTING

HEAT MODE SETTING typically consists of the following:

1. HEAT MODE: Enable or disable the HEAT mode
2. T1S RANGE: Selecting the range of target outlet water temperature
3. T4HMAX: Setting the maximum ambient operating temperature
4. T4HMIN: Setting the minimum operating ambient operating temperature
5. dT1SH: Setting the temperature difference for starting the unit
6. t_INTERVAL_H: Setting the compressor start time interval

How to set the Heat mode

To determine whether the HEAT mode is effective, go to MENU> FOR SERVICEMAN> HEAT MODE SETTING. Press OK. The following page be displayed:

3 HEAT MODE SETTING	
HEAT MODE	<input checked="" type="checkbox"/> YES <input type="checkbox"/> NON
T1S RANGE	<input checked="" type="checkbox"/> LOW <input type="checkbox"/> HIGH
T4HMAX	25°C
T4HMIN	-15°C
dT1SH	5°C
◀▶ SCROLL	

When the cursor is on HEAT MODE, Use ◀▶ to scroll to YES or NON and press OK to enable or disable the heat mode. When the cursor is on the T1S RANGE, use ◀▶ to scroll to YES or NON and press OK to select the range of outlet water temperature. When **LOW** is selected, the maximum target temperature is 55°C. If climate-related curve function (corresponds to “weather temperature set” in the user interface) is enabled, the curve selected is low temperature curve. When **HIGH** is selected, the maximum target temperature is 60°C. If climate-related curve function (corresponds to “weather temperature set” in the user interface) is enabled, the curve selected is high temperature curve.

When the cursor is on T4HMAX、T4HMIN、dT1SH、dTSH or t_INTERVAL_H, Use ◀▶ and ▼▲ to scroll and adjust the parameter.

T4HMAX is the maximum ambient operating temperature for heat mode. The unit will not work if the ambient temperature is higher.

T4HMIN is the minimum ambient operating temperature for heat mode. The unit will turn off if the ambient temperature is lower. The relationship between the operation of the unit and ambient temperature can be seen in the picture below:

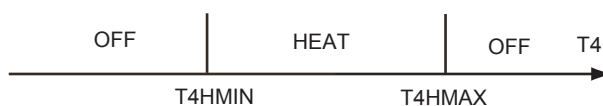

dT1SH is the temperature difference between T1 and T1S for starting the unit in heat mode.

When the target outlet water temperature $T1S < 47$, the unit will turn on or off as described below:

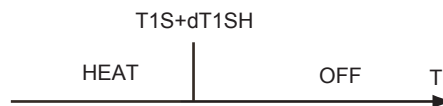

When the target outlet water temperature $T1S \geq 47$, the unit will on or off as described below:

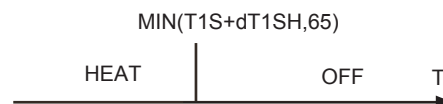

dTSH is the temperature difference between Ta (Ta is the room temperature) and TS for starting the unit when ROOM TEMP is enabled in TEMP.TYPE SETTING (refer to 10.7 Field setting/TEMP.TYPE SETTING). Only when Ta drops to a certain value will the unit turn on, and the unit will turn off if the Ta high enough. See diagram below. (only when ROOM TEMP is enabled will this function be available).

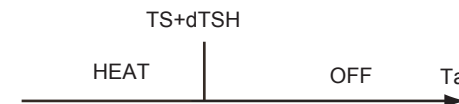

t_INTERVAL_H is the compressor start time interval in heat mode. When the compressor stops running, the next time that the compressor turns on should be “t_INTERVAL_H” and one minute later at least.

AUTO MODE SETTING

About AUTO SETTING

Controlling AUTO mode typically consists of the following:

1. T4AUTOCMIN: setting the minimum operating ambient temperature for cooling
2. T4AUTOHMAX: setting the maximum operating ambient temperature for heating

How to set the AUTO mode

To determine whether the AUTO mode is effective, go to MENU> FOR SERVICEMAN> AUTO MODE SETTING. Press OK. The following page is displayed.

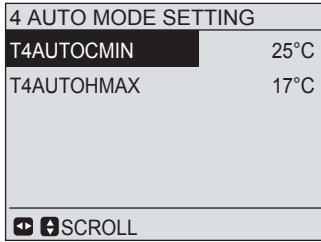

Use ◀ ▶ and ▼ ▲ to scroll and adjust the parameter.

T4AUTOCMIN is the minimum operating ambient temperature for cooling in auto mode. The unit will turn off if the ambient temperature is lower when in space cooling operation.
 T4AUTOHMAX is the maximum operating ambient temperature for heating in auto mode. The unit will turn off if the ambient temperature is higher when in space heating operation.
 The relationship between heat pump operation and ambient temperature is described in the picture below

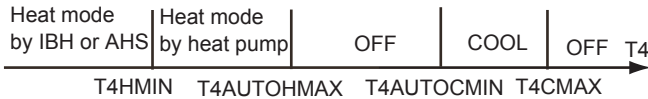

In the picture, AHS is an additional heating source. IBH is a backup heater in the unit.

TEMP. TYPE SETTING

About TEMP. TYPE SETTING

The TEMP. TYPE SETTING is used for selecting whether the water flow temperature or room temperature (detected by the temperature sensor attached in the user interface) is used to control the ON/OFF of the heat pump.

When ROOM TEMP. is enabled, the target outlet water temperature will be calculated from climate-related curves (refer to "10.1 Climate related curves").

How to enter the TEMP. TYPE SETTING

To enter the TEMP. TYPE SETTING, go to MENU> FOR SERVICEMAN> TEMP. TYPE SETTING. Press OK. The following page is displayed:

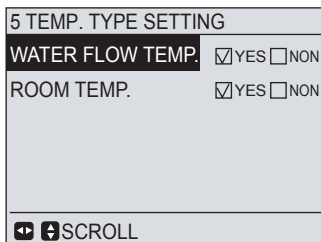

If you set WATER FLOW TEMP. to YES, and set ROOM TEMP. to NON, the water flow temperature will be displayed on the home page, and the water flow temperature will work as the target temperature.

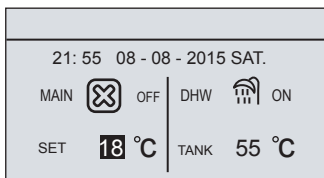

If application 7 is applied (refer to 8.7 Application 7) please set WATER FLOW TEMP. to YES, and set ROOM TEMP. to YES, then the water temperature will be displayed on the home page, and water temperature setpoint and room temperature setpoint can be set in the main page.

In this state, the first target outlet water temperature can be set in the main page, the second one can be calculated from the climate-related curves. In heat mode, the higher one will be the real target outlet temperature, while in cool mode, the lower one will be selected.

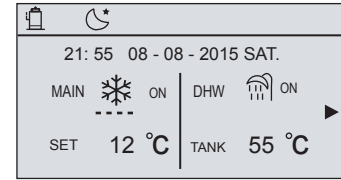

If ▶ is pressed, the main page will display the room temperature:

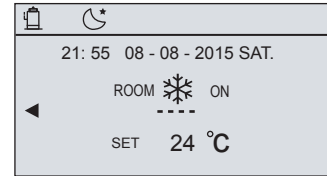

If application 4 (refer to 8.4 Application 4) is applied, please set WATER FLOW TEMP. to NON, and set ROOM TEMP. to YES, then the room temperature will be displayed on the home page, and the room temperature will work as the target temperature. The target outlet water temperature can be calculated from the climate related curves.

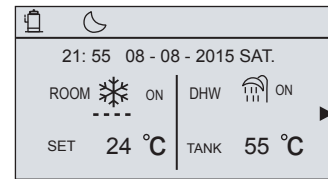

ROOM THERMOSTAT

About ROOM THERMOSTAT

The ROOM THERMOSTAT is used to set whether the room thermostat is available.

How to set the ROOM THERMOSTAT

To set the ROOM THERMOSTAT, go to MENU> FOR SERVICEMAN> ROOM THERMOSTAT. Press OK. The following page is displayed:

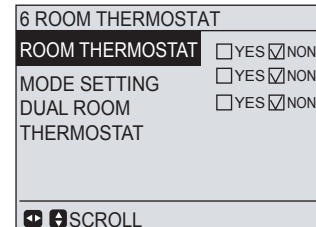

If room thermostat is available, select YES and press OK. In MODE SETTING, if YES is selected, the mode setting and the on/off function cannot be performed from the user interface. The timer function is unavailable; the operation mode, and the on/off function is decided by the room thermostat. The temperature setting can be done by the user interface. If NON is selected, the user interface can be used to set operation mode and target temperature, while the on/off function is determined by room thermostat; the timer function is unavailable. In DUAL ROOM THERMOSTAT, if YES is selected, the ROOM THERMOSTAT, MODE SETTING will turn to NON automatically, and the WATER FLOW TEMP. and ROOM TEMP. is forcibly set to YES. The timer function in the user interface is unavailable. The setting of operation mode and target temperature can be done on the user interface.

The "DUAL ROOM THERMOSTAT" function can be used only when application 6 (refer to 8.6 Application 6) is applied. If zone A requires heating/cooling (ON signal from room thermostat 5A), the unit will turn on. The operation mode and target temperature of outlet water should be set in the user interface. If zone B requires heating/cooling (ON signal from room thermostat 5B), the unit will turn on. The operation mode can be set in the user interface, the target temperature of outlet water will be decided by ambient temperature (target outlet water temperature is calculated from climate-related curves, if no curves are selected, the default curve will be curve 4). If no heating/cooling is required for both zone A and zone B (OFF signal from thermostat 5A and 5B), the unit will turn off.

NOTE: The setting in the user interface should correspond to the wiring of thermostat. If YES is selected in ROOM THERMOSTAT and the MODE SETTING is NON, the wiring of thermostat should follow method B. If the MODE SETTING is YES, then the wiring should follow method A, If "DUAL ROOM THERMOSTAT" is selected, the wiring of room thermostat should follow "method C" . (refer to "9.6.6 Connection for other components/For room thermostat")

Other HEATING SOURCE

About OTHER HEATING SOURCE

The OTHER HEATING SOURCE is used to set whether the backup heater, and additional heating sources like a boiler or solar energy kit is available.

How to set the OTHER HEATING SOURCE

To set the OTHER HEATING SOURCE, go to MENU> FOR SERVICEMAN> OTHER HEATING SOURCE, Press OK.

The following page will appear:

7 OTHER HEATING SOURCE	
7.1.BACKUP HEATER	<input checked="" type="checkbox"/> YES <input type="checkbox"/> NON
7.2.AHS	<input type="checkbox"/> YES <input checked="" type="checkbox"/> NON
7.3.SOLAR ENERGY	<input type="checkbox"/> YES <input checked="" type="checkbox"/> NON
SCROLL	

If backup heater is available, please select YES at BACKUP HEATER. Press OK and the following page is displayed:

7.1 BACKUP HEATER	
HEAT MODE	<input checked="" type="checkbox"/> YES <input type="checkbox"/> NON
DHW MODE	<input type="checkbox"/> YES <input checked="" type="checkbox"/> NON
T4_IBH_ON	-5°C
dT1_IBH_ON	5°C
t_IBH_DELAY	30MIN
t_IBH12_DELAY	5MIN
SCROLL	

When the cursor is on HEAT MODE or DHW MODE, Use ◀ ▶ to select YES or NON. If YES is selected, the backup heater will be available in the corresponding mode, otherwise it will be unavailable.

When the cursor is on T4_IBH_ON、dT1_IBH_ON、t_IBH_DELAY、or t_IBH12_DELAY, Use ◀ ▶ and ▼ ▲ to scroll and adjust the parameter.

T4_IBH_ON is the ambient temperature for starting the backup heater. If the ambient temperature rises above T4_IBH_ON, the backup heater will be unavailable. The relationship between operation of the backup heater and the ambient is shown in the picture below.

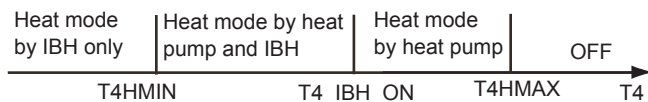

dT1_IBH_ON is the temperature difference between T1S and T1 for starting the backup heater. Only when at the $T1 < T1S - dT1_IBH_ON$ can the backup heater turn on. When a second backup heater is installed, if the temperature difference between T1S and T1 is larger than $dT1_IBH_ON + 2$, the second backup heater will turn on. The relationship between operation of the backup heater and the temperature difference is shown in the diagram below.

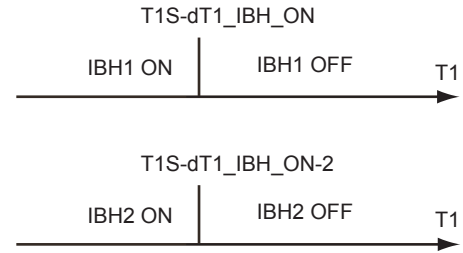

t_IBH_DELAY is the time that the compressor has run before the first backup heater turns on (if $T1 < T1S$).

t_IBH12_DELAY is the time that the first backup heater has run before the second backup heater turns on.

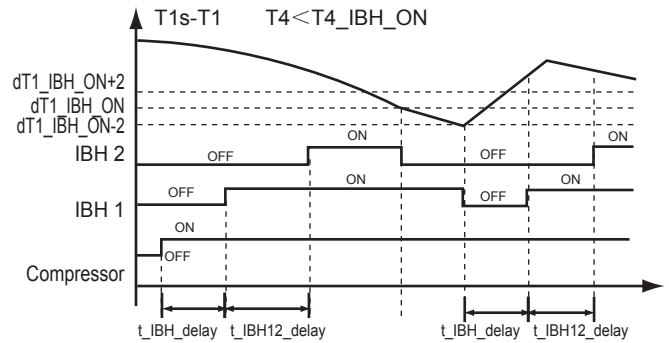

If an additional heating source is available, please select YES at the corresponding position. Press OK and the following page is displayed:

7.2 ADDITIONAL HEATING SOURCE	
HEAT MODE	<input checked="" type="checkbox"/> YES <input type="checkbox"/> NON
DHW MODE	<input type="checkbox"/> YES <input checked="" type="checkbox"/> NON
T4_AHS_ON	-5°C
dT1_AHS_ON	5°C
dT1_AHS_OFF	0°C
t_AHS_DELAY	30MIN
SCROLL	

When the cursor is on HEAT MODE or DHW MODE, Use ◀ ▶ to select YES or NON. If YES is selected, the additional heating source will be available in the corresponding mode, otherwise it will be unavailable.

NOTE: If YES is selected in HEAT MODE, the installation of additional heating source should follow "8.5 Application 5/Application a" or "8.5 Application 5/Application b". If YES is selected in DHW MODE, the installation of additional heating source should follow "8.5 Application 5/Application c".

When the cursor is on T4_AHS_ON、dT1_AHS_ON、dT1_AHS_OFF or t_AHS_DELAY, Use ◀ ▶ and ▼ ▲ to scroll and adjust the parameter.

T4_AHS_ON is the ambient temperature for starting the additional heating source. When the ambient temperature rises above T4_AHS_ON, the additional heating source will be unavailable. The relationship between the operation of additional heating source and ambient temperature is shown in the picture below:

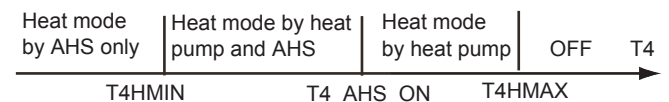

dT1_AHS_ON is the temperature difference between T1S and T1B for turning the additional heating source on (only when $T1B < T1S - dT1_AHS_ON$ will the unit turn on), dT1_AHS_OFF is the temperature difference between T1S and T1B for turning the additional heating source off (when $T1B \geq T1S + dT1_AHS_OFF$ the additional heating source will turn off), t_AHS_DELAY is the time that the compressor has run before starting the additional heating source. It should be shorter than the additional heating source start time interval. The operation of the heat pump and the additional heating source is shown below:

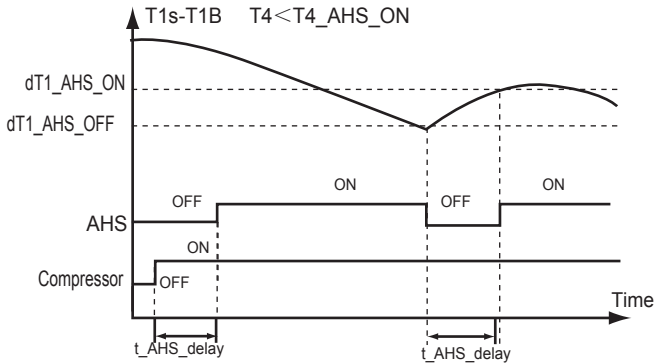

If solar energy kit is installed, please select YES at "7.3 SOLAR ENERGY", then the solar pump will operate when the solar energy kit operating for domestic hot water heating, and the heat pump will stop operating for domestic hot water heating.

HOLIDAY AWAY SETTING

About HOLIDAY AWAY SETTING

The HOLIDAY AWAY SETTING is used to set the outlet water temperature to prevent freezing when away for holiday.

How to enter the HOLIDAY AWAY SETTING

To enter the HOLIDAY AWAY SETTING, go to MENU> FOR S ERVICEMAN> HOLIDAY AWAY SETTING. Press OK. The following page is displayed:

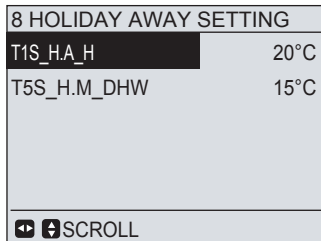

When the cursor is on T1S_H.A._H or T5S_H.M._DHW, Use ◀ ▶ and ▼ ▲ to scroll and adjust the parameter, T1S_H.A._H is the target outlet water temperature for space heating when in holiday away mode. T5S_H.M._DHW is the target outlet water temperature for domestic hot water heating when in holiday away mode.

SERVICE CALL

About SERVICE CALL

The installers can set the phone number of the local dealer in SERVICE CALL. If the unit doesn't work properly, call this number for help.

How to set the SERVICE CALL

To set the SERVICE CALL, go to MENU> FOR SERVICEMAN> SERVICE CALL. Press OK. The following page is displayed:

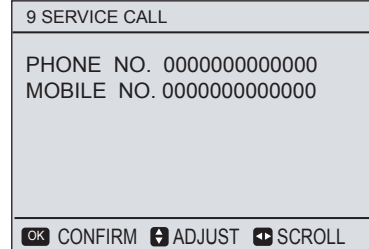

Use ▼ ▲ to scroll and set the phone number. The maximum length of the phone number is 13 digits, if the length of phone number is short than 12, please input ■, as shown below:

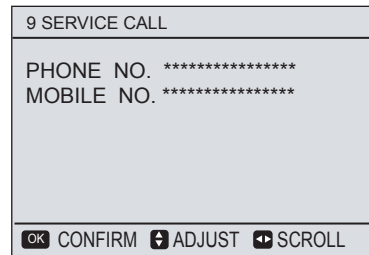

The number displayed on the user interface is the phone number of your local dealer.

RESTORE FACTORY SETTINGS

About RESTORE FACTORY SETTINGS

The RESTORE FACTORY SETTING is used to restore all the parameters set in the user interface to the factory setting.

How to set the RESTORE FACTORY SETTINGS

To restore factory settings, go to MENU> FOR SERVICEMAN> RESTORE FACTORY SETTINGS. Press OK. The following page is displayed:

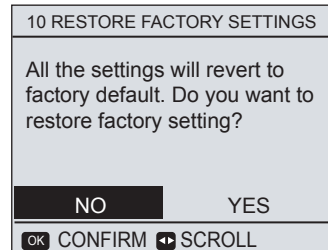

Use ◀ ▶ to scroll the cursor to YES and press OK. the following page will be displayed:

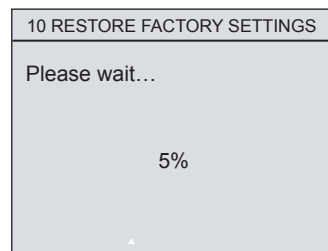

After a few seconds, all the parameters set in the user interface will be restored to factory settings

TEST RUN

About TEST RUN

TEST RUN is used to check correct operation of the valves, air purge, circulation pump operation, cooling, heating and domestic water heating.

How to enter TEST RUN

To enter test run, go to MENU> FOR SERVICEMAN> TEST RUN. Press OK. The following page is displayed:

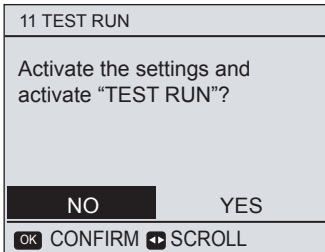

If YES is selected, the following page is displayed:

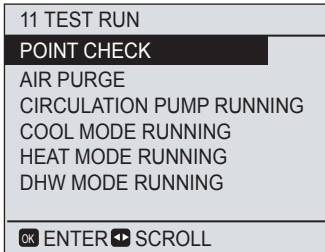

Use ▼ ▲ to scroll to the mode you want to run and press OK. The unit will run as selected.

If POINT CHECK is selected, the following page will appear:

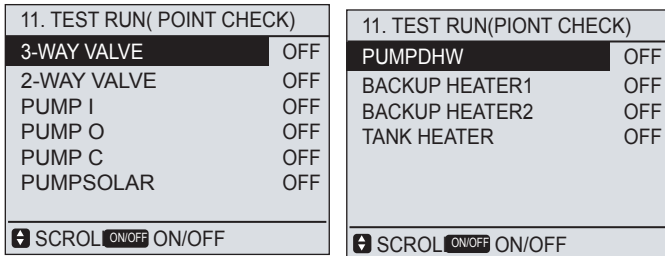

Use ▼ ▲ to scroll to the components you want to check and press ON/OFF. For example, when 3-WAY VALVE is selected and ON/OFF is pressed, if the 3-way valve is open/close, then the operation of 3-way valve is normal, and so are other components.

If you select AIR PURGE and OK is pressed, the page will displayed as follows:

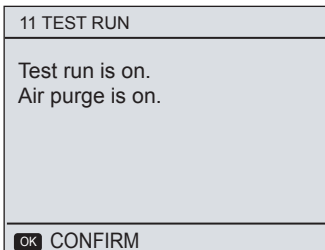

When in air purge mode, the 3-way valve will open, the 2-way valve will close. 60s later the pump in the unit (PUMPI) will operate for 10min during which the flow switch will not work. After the pump stops, the 3-way valve will close and the 2-way valve will open. 60s later both the PUMPI and PUMPO will operate until the next command is received.

When CIRCULATION PUMP RUNNING is selected, the page will displayed as follows:

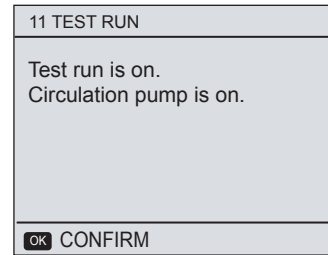

When circulation pump running is turned on, all running components will stop. 60 minutes later, the 3-way valve will open, the 2-way valve will close, 60 seconds later PUMPI will operate. 30s later, if the flow switch checked normal flow, PUMPI will operate for 3min, after the pump stops, the 3-way valve will close and the 2-way valve will open. 60s later the both PUMPI and PUMPO will operate, 2 mins later, the flow switch will check the water flow. If the flow switch closes for 15s, PUMPI and PUMPO will operate until the next command is received.

When the COOL MODE RUNNING is selected, the page will displayed as follows:

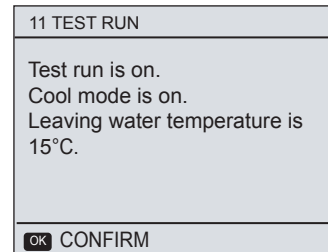

During COOL MODE test running, the default target outlet water temperature is 7°C. The unit will operate until the water temperature drops to a certain value or the next command is received.

When the HEAT MODE RUNNING is selected, the page will displayed as follows:

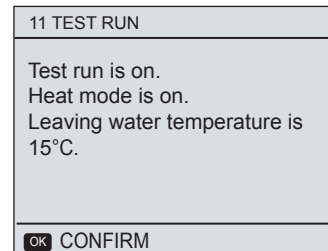

During HEAT MODE test running, the default target outlet water temperature is 35°C. The first backup heater will turn on after the compressor runs for 10 min, 60s later the second backup heater will turn on. After the two backup heater runs for 3 min, both backup heaters will turn off, the heat pump will operate until the water temperature increase to a certain value or the next command is received.

When the DHW MODE RUNNING is selected, the page will displayed as follows:

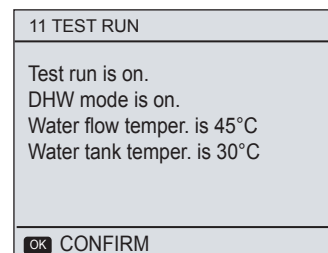

During DHW MODE test running, the default target temperature of the domestic water is 55°C. The booster heater will turn on after the compressor runs for 10min. The booster heater will turn off 3 min later, the heat pump will operate until the water temperature increase to a certain value or the next command is received.

During test run, all buttons except OK are invalid. If you want to turn off the test run, please press OK. For example ,when the unit is in air purge mode, after you press OK, the page will displayed as follows:

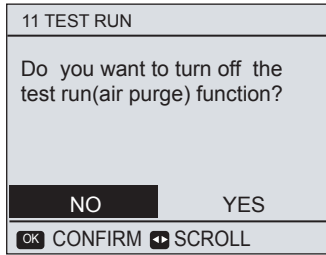

Use ◀ ▶ to scroll the cursor to YES and press OK. The test run will turn off.

SPECIAL FUNCTION

About SPECIAL FUNCTION

The SPECIAL FUNCTION contains AIR PURGE, PREHEATING FOR FLOOR, and FLOOR DRYING UP. It's used in special situations. For example: the initial start of the unit, initial running of floor heating.

NOTE: the special functions can be used by service man only, during special function operating other functions(SCHDULE,HOLIDAY AWAY, HOLIDAY HOME) can't be used.

How to enter SPECIAL FUNCTION

Go to MENU> FOR SERVICEMAN> SPECIAL FUNCTION.

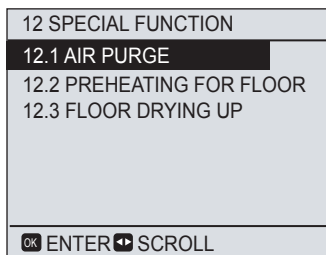

Use ▼ ▲ to scroll and use OK to enter.

During first operation of the unit, air may remain in the system which can case malfunctions during operation. It is necessary to run the air purge function to release the air (make sure the air purge valve is open).

Go to FOR SERVICEMAN > 12 SPECIAL FUNCTION>12.1AIR PURGE:

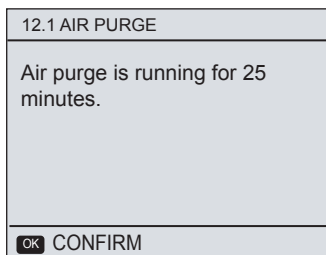

During air purge, the 3-way valve will open, and the 2-way valve will close. 60 seconds later the pump in the unit (PUMPI) will operate for 10 min, during which the flow switch will not work. After the pump stops, the 3-way valve will close and the 2-way valve will open. 60s later the both the PUMPI and PUMPO will operate until the stop command is received.

The number displayed on the page is the time that the air purge has run. During air purge, all the buttons except OK are invalid. If you want to turn off the air purge, please press OK, then the following page is displayed:

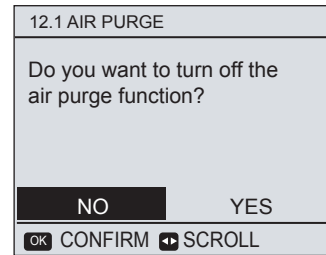

Use◀ ▶ to scroll and use OK to confirm.

If PREHEATING FOR FLOOR is selected, after press OK ,the page will displayed as follows:

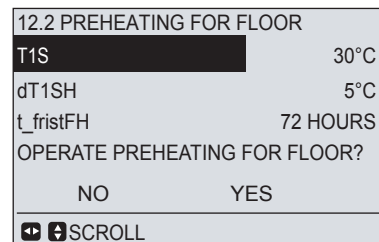

When the cursor is on T1S, dT1SH or t_fristFH, Use ◀ ▶ and ▼ ▲ to scroll and adjust the parameter.

T1S is the target outlet water temperature in preheating for floor mode. The T1S set here should be equal to the target outlet water temperature set in the main page.

dT1SH is the temperature difference for stopping the unit. (When $T1 \geq T1S + dT1S$ occurs the heat pump will turn off)

t_fristFH is the time last for preheating floor.

The operation of the unit during preheating for floor described in the picture below:

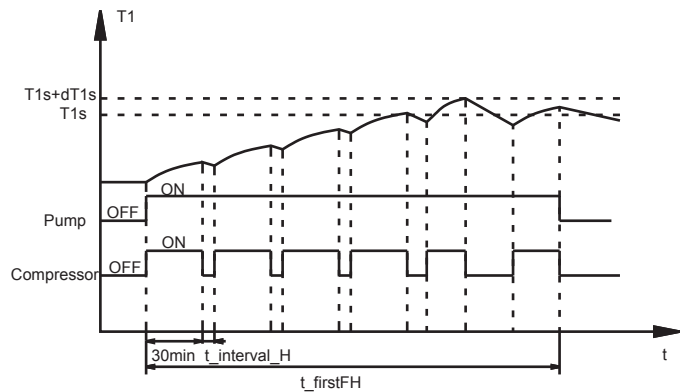

When the cursor is on OPERATE PREHEATING FOR FLOOR, Use ◀ ▶ to scroll to YES and press OK. The page will be displayed as follows:

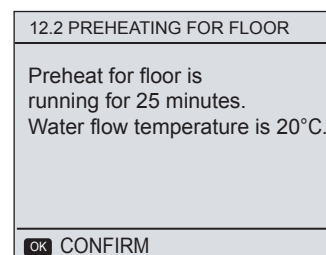

During preheating for floor, all the buttons except OK are invalid. If you want to turn off the preheating for floor, please press OK. The following page will be displayed:

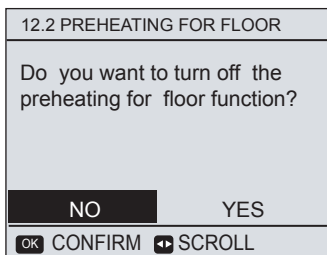

Use ◀ ▶ to scroll the cursor to YES and press OK, the preheating for floor will turn off.

Before floor heating, if large amount of water remains on the floor, the floor may be warped or even rupture during floor heating operation, in order to protect the floor, floor drying is necessary, during which the temperature of the floor should be increased gradually. If FLOOR DRYING UP is selected, after press OK, the page will be displayed as follows:

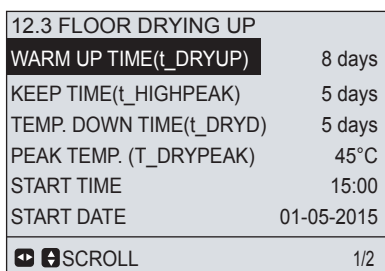

When the cursor is on **WARM UP TIME (t_DRYUP)**, **KEEP TIME (t_HIGHPEAK)**, **TEMP. DOWN TIME (t_DRYD)**, **PEAK TEMP. (T_DRYPEAK)**, **START TIME** or **START DATE**, Use ◀ ▶ and ▼ ▲ to scroll and adjust the parameter.

t_DRYUP is the day for warming up.

t_HIGHPEAK is the continue days in high temperature.

t_DRYD is the day of dropping temperature

T_DRYPEAK is the target peak temperature of water flow during floor drying up.

The target outlet water temperature during floor drying up described in the picture below:

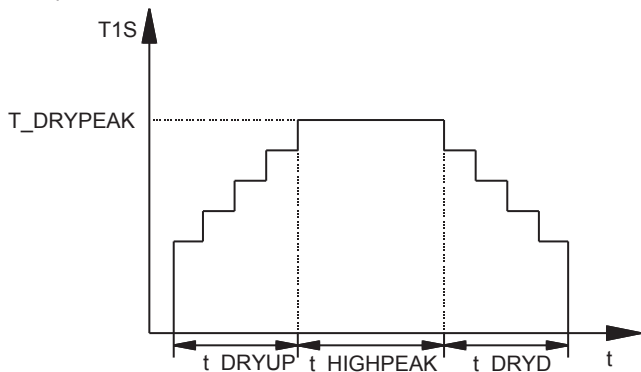

When the cursor is on OPERATE FLOOR DRYING? Use ◀ ▶ to scroll to YES and press OK. The page will be displayed as follows:



During floor drying, all the buttons except OK are invalid. When the heat pump malfunctions, the floor drying mode will turn off when the backup heater and additional heating source is unavailable. If you want to turn off floor drying up, please press OK. The following page will be displayed:

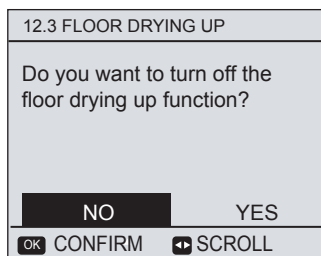

Use ◀ ▶ to scroll the cursor to YES and press OK. Floor drying will turn off.

AUTO RESTART

About AUTO RESTART

The AUTO RESTART function is used to select whether the unit reapplies the user interface settings at the time when power returns after a power supply failure.

How to set the AUTO RESTART

Go to MENU> FOR SERVICEMAN> AUTO RESTART.

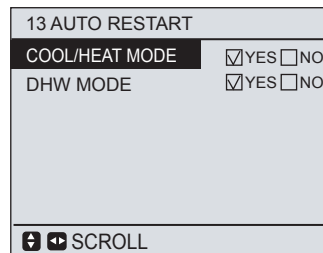

Use ▼, ▲, ◀, ▶ to scroll and use OK to select YES or NON to enable or disable the auto restart function. If the auto restart function is enabled, when power returns after a power supply failure, the AUTO RESTART function reapplies the user interface settings at the time of the power supply failure. If this function is disabled, when power returns after a power supply failure, the unit won't auto restart.

Description of terms

The terms related to this unit are shown in the table below

Parameter	Illustration
T1	Outlet water temperature of backup heater
T1B	Outlet water temperature of additional heating source
T1S	Target outlet water temperature
T2	Temperature of refrigerant at outlet /inlet of plate heat exchanger when in heat mode/cool mode
T2B	Temperature of refrigerant at inlet /outlet of plate heat exchanger when in heat mode/cool mode
T3	Temperature of tube at outlet/inlet of condenser when in cool/heat mode
T4	Ambient temperature
T5	Temperature of domestic hot water
Th	Suction temperature
Tp	Discharge temperature
TW_in	Inlet water temperature of plate heat exchanger
TW_out	Outlet water temperature of plate heat exchanger
AHS	Additional heating source
IBH1	The first backup heater
IBH 2	The second backup heater
TBH	Backup heater in the domestic hot water tank
Pe	Evaporate/condense pressure in cool/heat mode

11 TEST RUN AND FINAL CHECK

The installer is obliged to verify correct operation of unit after installation.

11.1 Final check

Before switching on the unit, read following recommendations:

- When the complete installation and all necessary settings have been carried out, close all front panels of the unit and refit the unit cover.
- The service panel of the switch box may only be opened by a licensed electrician for maintenance purposes.



NOTE

That during the first running period of the unit, required power input may be higher than stated on the nameplate of the unit. This phenomenon originates from the compressor that needs elapse of a 50 hours run in period before reaching smooth operation and stable power consumption.

11.2 Test run operation (manual)

If required, the installer can perform a manual test run operation at any time to check correct operation of air purge, heating, cooling and domestic water heating, refer to **10.7 Field settings/test run**.

12 MAINTENANCE AND SERVICE

In order to ensure optimal availability of the unit, a number of checks and inspections on the unit and the field wiring have to be carried out at regular intervals.

This maintenance needs to be carried out by your local technician.

In order to ensure optimal availability of the unit, a number of checks and inspections on the unit and the field wiring have to be carried out at regular intervals.

This maintenance has to be carried out by your local Midea technician.



DANGER

ELECTRIC SHOCK

- Before carrying out any maintenance or repair activity, always switch off the circuit breaker on the supply panel, remove the fuses (or switch off the circuit breakers) or open protection devices of the unit.
 - Make sure that before starting any maintenance or repair activity that the power supply to the outdoor unit is switched off.
 - Do not touch live parts for 10 minutes after the power supply is turned off because of high voltage risk.
 - The heater for the compressor may operate even in stop mode.
 - Please note that some sections of the electric component box are hot.
 - Make sure you do not touch a conductive section.
 - Do not rinse the unit. This may cause electric shocks or fire.
 - When service panels are removed, live parts can be easily touched by accident.
Never leave the unit unattended during installation or servicing when service panel is removed.
-

The described checks must be executed at least once a year by qualified personnel.

1. Water pressure
Check if the water pressure is above 1 bar. If necessary add water.
2. Water filter
Clean the water filter.
3. Water pressure relief valve
Check for correct operation of the pressure relief valve by turning the black knob on the valve counter-clockwise:
 - If you do not hear a clacking sound, contact your local dealer.
 - In case the water keeps running out of the unit, close both the water inlet and outlet shut-off valves first and then contact your local dealer.
4. Pressure relief valve hose
Check that the pressure relief valve hose is positioned appropriately to drain the water.
5. Backup heater vessel insulation cover
Check that the backup heater insulation cover is fastened tightly around the backup heater vessel.
6. Domestic hot water tank pressure relief valve (field supply)
Applies only to installations with a domestic hot water tank.
Check for correct operation of the pressure relief valve on the domestic hot water tank.
7. Domestic hot water tank booster heater
Applies only to installations with a domestic hot water tank.
It is advisable to remove lime buildup on the booster heater to extend its life span, especially in regions with hard water. To do so, drain the domestic hot water tank, remove the booster heater from the domestic hot water tank and immerse in a bucket (or similar) with lime-removing product for 24 hours.
8. Unit switch box
 - Carry out a thorough visual inspection of the switch box and look for obvious defects such as loose connections or defective wiring.
 - Check for correct operation of contactors with an ohm meter. All contacts of these contactors must be in open position.
9. Use of glycol
(Refer to **9.3 Water pipework Caution: "Use of glycol"**)
Document the glycol concentration and the pH-value in the system at least once a year.
 - A PH-value below 8.0 indicates that a significant portion of the inhibitor has been depleted and that more inhibitor needs to be added.
 - When the PH-value is below 7.0 then oxidation of the glycol occurred, the system should be drained and flushed thoroughly before severe damage occurs.Make sure that the disposal of the glycol solution is done in accordance with relevant local laws and regulations.

13 TROUBLE SHOOTING

This section provides useful information for diagnosing and correcting certain troubles which may occur in the unit. This troubleshooting and related corrective actions may only be carried out by your local technician.

13.1 General guidelines

Before starting the troubleshooting procedure, carry out a thorough visual inspection of the unit and look for obvious defects such as loose connections or defective wiring.



WARNING

When carrying out an inspection on the switch box of the unit, always make sure that the main switch of the unit is switched off.

When a safety device was activated, stop the unit and find out why the safety device was activated before resetting it. Under no circumstances can safety devices be bridged or changed to a value other than the factory setting. If the cause of the problem cannot be found, call your local dealer.

If the pressure relief valve is not working correctly and is to be replaced, always reconnect the flexible hose attached to the pressure relief valve to avoid water dripping out of the unit!



NOTE

For problems related to the optional solar kit for domestic water heating, refer to the troubleshooting in the Installation & Owner's manual for that kit.

13.2 General symptoms

Symptom 1: The unit is turned on but the unit is not heating or cooling as expected

POSSIBLE CAUSES	CORRECTIVE ACTION
The temperature setting is not correct.	Check the controller set point. T4HMAX, T4HMIN in heat mode. T4CMAX, T4CMIN in cool mode. T4DHWMAX, T4DHWMIN in DHW mode.
The water flow is too low.	<ul style="list-style-type: none"> Check that all shut off valves of the water circuit are completely open. Check if the water filter needs cleaning. Make sure there is no air in the system (purge air). Check on the manometer that there is sufficient water pressure. The water pressure must be >1 bar (water is cold). Make sure that the expansion vessel is not broken. Check that the resistance in the water circuit is not too high for the pump
The water volume in the installation is too low.	Make sure that the water volume in the installation is above the minimum required value (refer to " 9.3 water pipework/Checking the water volume and expansion vessel pre-pressure ").

Symptom 2: The unit is turned on but the compressor is not starting (space heating or domestic water heating)

POSSIBLE CAUSES	CORRECTIVE ACTION
The unit must start up out of its operation range (the water temperature is too low).	<p>In case of low water temperature, the system utilizes the backup heater to reach the minimum water temperature first (12°C).</p> <ul style="list-style-type: none"> Check that the backup heater power supply is correct. Check that the backup heater thermal fuse is closed. Check that the backup heater thermal protector is not activated. Check that the backup heater contactors are not broken.

Symptom 3: Pump is making noise (cavitation)

POSSIBLE CAUSES	CORRECTIVE ACTION
There is air in the system.	Purge air.
Water pressure at pump inlet is too low.	<ul style="list-style-type: none"> Check on the manometer that there is sufficient water pressure. The water pressure must be > 1 bar (water is cold). Check that the manometer is not broken. Check that the expansion vessel is not broken. Check that the setting of the pre- pressure of the expansion vessel is correct (refer to "9.3 water pipework/Checking the water volume and expansion vessel pre-pressure").

Symptom 4: The water pressure relief valve opens

POSSIBLE CAUSES	CORRECTIVE ACTION
The expansion vessel is broken.	Replace the expansion vessel.
The filling water pressure in the installation is higher than 0.3MPa.	Make sure that the filling water pressure in the installation is about 0.15~0.20MPa (refer to " 9.3 water pipework/Checking the water volume and expansion vessel pre-pressure ").

Symptom 5: The water pressure relief valve leaks

POSSIBLE CAUSES	CORRECTIVE ACTION
Dirt is blocking the water pressure relief valve outlet.	<p>Check for correct operation of the pressure relief valve by turning the red knob on the valve counter clockWise:</p> <ul style="list-style-type: none"> If you do not hear a clacking sound, contact your local dealer. In case the water keeps running out of the unit, close both the water inlet and outlet shut-off valves first and then contact your local dealer.

Symptom 6: Space heating capacity shortage at low outdoor temperatures

POSSIBLE CAUSES	CORRECTIVE ACTION
Backup heater operation is not activated.	<p>Check that the "OTHER HEATING SOURCE/ BACKUP HEATER" is enabled, see "10.7 Field settings"</p> <p>Check whether or not the thermal protector of the backup heater has been activated (refer to "Controls parts for backup heater (IBH)" in page 22 for location of the reset button). Check if booster heater is running, the backup heater and booster heater can't operate simultaneously.</p>
Too much heat pump capacity is used for heating domestic hot water (applies only to installations with a domestic hot water tank).	<p>Check that the 't_DHWHP_MAX' and 't_DHWHP_RESTRICT' are configured appropriately:</p> <ul style="list-style-type: none"> Make sure that the 'DHW PRIORITY' in the user interface is disabled. Enable the "T4_TBH_ON" in the user interface/FOR SERVICEMAN to activate the booster heater for domestic water heating.

Symptom 7: Heat mode can't change to DHW mode immediately

POSSIBLE CAUSES	CORRECTIVE ACTION
volume of tank is too small and the location of water temperature probe not high enough	<ul style="list-style-type: none"> • set dT1s5 to 20, and set t_DHWHP_RESTRICT to minimum value • set dT1SH to 2 • enable TBH, and TBH should be controled by the outdoor unit • if AHS(boiler) is available, turn boiler on first, if requirement for turn heat pump on is fulfilled, the heat pump will turn on • if both TBH and AHS are not available, try to change the postion of T5 probe(REFER TO 1.1 General information/Domestic hot water tank)

Symptom 8: DHW mode can't change to Heat mode immediately

POSSIBLE CAUSES	CORRECTIVE ACTION
Heat exchanger for space heating not big enough	<ul style="list-style-type: none"> • set t_DHWHP_MAX to minimum value, the suggested value is 60min • if circulating pump out of unit is not controlled by unit, try to connect it to the unit • add 3-way valve at the inlet of fan coil to ensure enough water flow
Space heating load is small	Normal , no need for heating
Disinfect function is enabled but without TBH	<ul style="list-style-type: none"> • Disable disinfect function • add TBH or AHS for DHW mode

Symptom 9: DHW mode heat pump stop work but setpoint not reached, space heating require heat but unit stay in DHW mode

POSSIBLE CAUSES	CORRECTIVE ACTION
surface of coil in the tank not large enough	the same solution for Symptom 7
TBH or AHS not available	heat pump will stay in DHW mode untill t_DHWHP_MAX reached or setpoint is reached. Add TBH or AHS for DHW mode, TBH and AHS should be controlled by the unit

13.3 PARAMETERS CHECK IN THE UNIT

To check the parameters of hydraulic box, open door 2 and you'll see the PCB like following, the digital display will show the temperature of outlet water in normal condition ('0' will display if the unit is off or error code will display if error occurs). Long press the check button and the digital display will show the operating mode. Then press the check button in sequence. The digital display will show the value, the implication of the value illustrated in the diagram below:

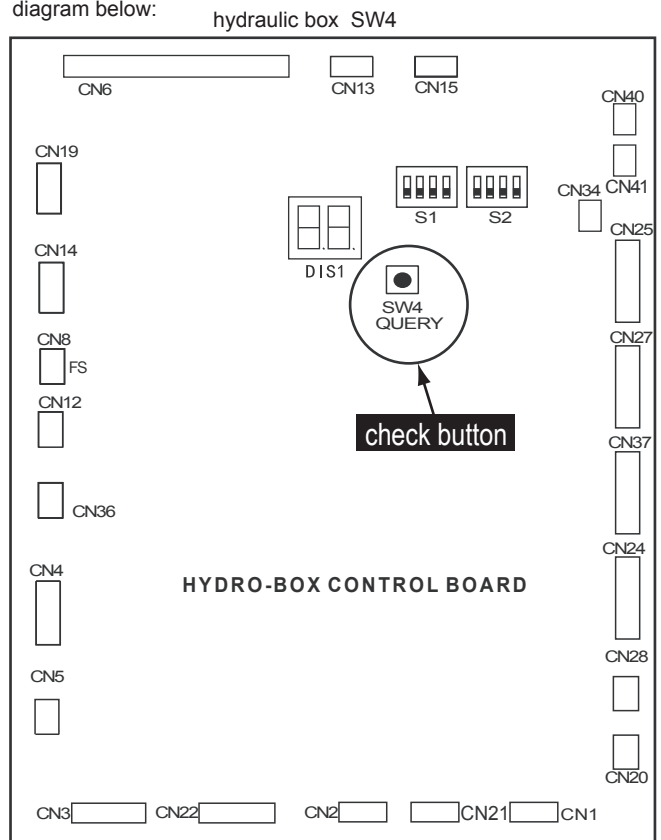

Number	Implication
0	Temperature of outlet water when unit is on, when the unit is off, '0' will display
1	Operation mode(0—OFF, 2—COOL, 3—HEAT, 5—Water heating)
2	Capacity requirement before correction
3	Capacity requirement after correction
4	Outlet water temperature of backup heater
5	Outlet water temperature of additional heating source
6	Target outlet water temperature calculated from climate-related curves
7	Room temperature
8	Temperature of domestic hot water
9	Temperature of refrigerant at outlet /inlet of plate heat exchanger when in heat mode/cool mode
10	Temperature of refrigerant at inlet /outlet of plate heat exchanger when in heat mode/cool mode
11	Temperature of water at outlet of plate heat exchanger
12	Temperature of water at inlet of plate heat exchanger
13	Ambient temperature
14	Current of backup heater 1
15	Current of backup heater 2
16	Error/protection code for the last time, "—" will display if no error/protection occur
17	Error/protection code for the second last time, "—" will display if no error/protection occur
18	Error/protection code for the third last time, "—" will display if no error/protection occur
19	Version of software (hydraulic module)

To check the parameters on the refrigerant side, open door 1 and you'll see the PCB like the following (different for 1-phase and 3-phase unit): the digital display will show the present compressor frequency ('0' will display if the unit is off or error code will display if error occurs). Long press the check button and the digital display will show the operating mode, and then press the check button in sequence. The digital display will show the value, the implication of the value is shown in the diagram below:

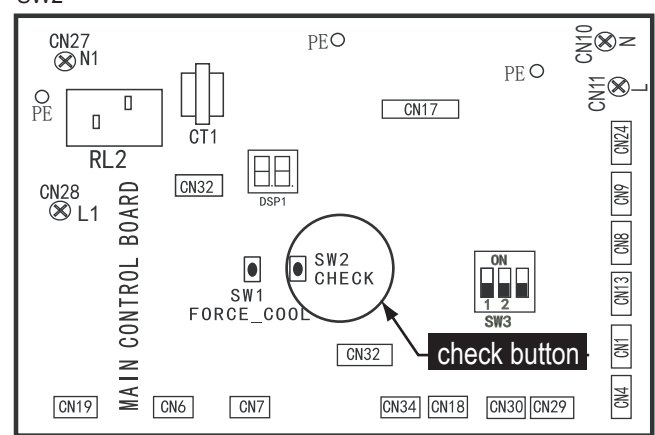
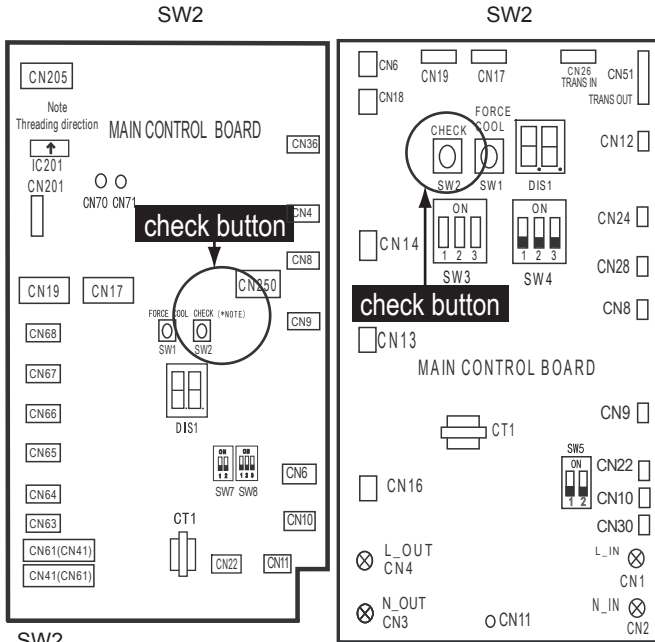

Number	Implication
0	Frequency of compressor at present
1	Operation mode (0—Standby, 2—COOL, 3—HEAT, 5—refrigerant recovery)
2	Fan speed
3	Frequency from hydraulic module
4	Frequency after restriction by the refrigerant system
5	Temperature of tube at outlet/inlet of condenser when in cool/heat mode
6	Ambient temperature
7	Discharge temperature
8	Suction temperature (when the temperature lower than -9℃, ". " Will stand for negative sign)
9	The opening of EEV (the value display multiply 8 will be the actual opening)
10	Actual current
11	Actual voltage
12	Pressure of refrigerant (evaporate/condense pressure when in cool /heat mode)
13	Version of software (refrigerant system, PCB B)
14	Error/protection code for the last time, "nn"will display if no error/protection occurs
15	—

13.4 Error codes

When a safety device is activated, an error code will be displayed on the user interface.

A list of all errors and corrective actions can be found in the table below.

Reset the safety by turning the unit OFF and back ON.

In case this procedure for resetting the safety is not successful, contact your local dealer.

Error code	Malfunction or protection	Failure cause and Corrective action
E0	Flow switch error (E8 displayed 3 times)	<ol style="list-style-type: none"> 1.The wire circuit is short connected or open. Reconnect the wire correctly. 2.Water flow rate is too low. 3. Water flow switch is failed, switch is open or close continuously, change the water flow switch.
E1	Phase sequence fault(only for three-phase unit)	<ol style="list-style-type: none"> 1.Check the power supply cables should be connected stable, to avoid phase loss. 2.Check the power supply cables sequence, change any two cables sequence of the three power supply cables.
E2	Communication error between user interface and main control board of hydraulic module	<ol style="list-style-type: none"> 1.wire doesn't connect between wired controller and unit. connect the wire. 2.Communication wire sequence is not right. Reconnect the wire in the right sequence. 3. Whether there is a high magnetic field or high power interfere, such as lifts, large power transformers, etc.. <p>To add a barrier to protect the unit or to move the unit to the other place.</p>
E3	The backup heater exchanger outlet water temperature sensor (T1) error.	<ol style="list-style-type: none"> 1. The T1 sensor connector is loosen. Reconnect it. 2.The T1 sensor connector is wet or there is water in. remove the water, make the connector dry. Add waterproof adhesive. 3.The T1 sensor failure, change a new sensor.

Error code	Malfunction or protection	Failure cause and Corrective action
<i>E4</i>	The domestic hot water temperature sensor (T5) error.	1.The T5 sensor connector is loosen. Reconnect it. 2.The T5 sensor connector is wet or there is water in. remove the water, make the connector dry. Add waterproof adhesive 3.The T5 sensor failure, change a new sensor.
<i>E5</i>	The condenser outlet refrigerant temperature sensor (T3)error.	1. The T3 sensor connector is loosen. Reconnect it. 2.The T3 sensor connector is wet or there is water in. remove the water, make the connector dry. Add waterproof adhesive 3. The T3 sensor failure, change a new sensor.
<i>E6</i>	The ambient temperature sensor (T4) error.	1. The T4 sensor connector is loosen. Reconnect it. 2.The T4 sensor connector is wet or there is water in. remove the water, make the connector dry. Add waterproof adhesive 3. The T4 sensor failure, change a new sensor.
<i>E8</i>	Water flow failure	Check that all shut off valves of the water circuit are completely open. 1 Check if the water filter needs cleaning. 2 Refer to "9.4 Charging water" 3 Make sure there is no air in the system(purge air). 4 Check on the manometer that there is sufficient water pressure. The water pressure must be >1 bar. 5 Check that the pump speed setting is on the highest speed. 6 Make sure that the expansion vessel is not broken. 7 Check that the resistance in the water circuit is not too high for the pump (refer to "Setting the pump speed"). 8 If this error occurs at defrost operation (during space heating or domestic water heating), make sure that the backup heater power supply is wired correctly and that fuses are not blown. 9 Check that the pump fuse and PCB fuse are not blown.

Error code	Malfunction or protection	Failure cause and Corrective action
<i>E9</i>	Suction temperature sensor(Th) error	1. The Th sensor connector is loosen. Re connect it. 2.The Th sensor connector is wet or there is water in. remove the water, make the connector dry. Add waterproof adhesive 3. The Th sensor failure, change a new sensor.
<i>EA</i>	Discharge temperature sensor(Tp) error	1. The Tp sensor connector is loosen. Re connect it. 2.The Tp sensor connector is wet or there is water in. remove the water, make the connector dry. Add waterproof adhesive 3. The Tp sensor failure, change a new sensor.
<i>Ed</i>	inlet water temperature sensor(Tw_in) error	1. The Tw_in sensor connector is loosen. Re connect it. 2.The Tw_in sensor connector is wet or there is water in. remove the water, make the connector dry. Add waterproof adhesive 3. The Tw_in sensor failure, change a new sensor.
<i>EE</i>	The main control board of hydraulic module EEprom failure	1. The EEprom parameter is error. rewrite the EEprom data. 2. EEprom chip part is broken, change a new EEprom chip part. 3. main control board of hydraulic module is broken, change a new PCB.
<i>HO</i>	Communication error between main control board PCB B and main control board of hydraulic module	1.wire doesn't connect between main control board PCB B and main control board of hydraulic module. connect thewire. 2.Communication wire sequence is not right. Reconnect the wire in the right sequence. 3. Whether there is a high magnetic field or high power interfere, such as lifts, large power transformers, etc.. To add a barrier to protect the unit or to move the unit to the other place.
<i>HI</i>	Communication error between inverter module PCB A and main control board PCB B	1. Whether there is power connected to the PCB and driven board. Check the PCB indicator light is on or off. If Light is off, reconnect the power supply wire.

Error code	Malfunction or protection	Failure cause and Corrective action
H1	Communication error between inverter module PCB A and main control board PCB B	2.if light is on, check the wire connection between the main PCB and driven PCB, if the wire loosen or broken, reconnect the wire or change a new wire. 3. Replace a new main PCB and driven board in turn.
H2	The plate heat exchanger refrigerant inlet(liquid pipe) temperature sensor(T2) error.	1.The T2 sensor connector is loosen. Re connect it. 2.The T2 sensor connector is wet or there is water in. remove the water, make the connector dry. Add waterproof adhesive 3. The T2 sensor failure, change a new sensor.
H3	The plate heat exchanger refrigerant outlet(gas pipe) temperature sensor (T2B) error.	1. The T2B sensor connector is loosen. Re connect it. 2.The T2B sensor connector is wet or there is water in. remove the water, make the connector dry. Add waterproof adhesive 3. The T2B sensor failure, change a new sensor.
H4	Three times P6 protect	Same to P6
H5	The indoor temperature sensor(Ta) error	1. The Ta sensor is in the interface; 2. The Ta sensor failure change a new sensor or change a new interface.
H6	The DC fan failure	1. Strong wind or typhoon below toward to the fan, to make the fan running in the opposite direction. Change the unit direction or make shelter to avoid typhoon below to the fan. 2.fan motor is broken, change a new fan motor.
H7	Main circuit voltage failure	1. Whether the power supply input is in the available range. 2. Power off and power on for several times rapidly in short time. Remain the unit power off for more than 3 minutes than power on. 3. the circuit defect part of Main control board is defective. Replace a new Main PCB.

Error code	Malfunction or protection	Failure cause and Corrective action
HB	Pressure sensor failure	1. Pressure sensor connector is loosen, reconnect it. 2. Pressure sensor failure. change a new sensor.
HS	The system outlet water temperature sensor T1B failure.	1. The T1B sensor connector is loosen. Reconnect it. 2.The T1B sensor connector is wet or there is water in. remove the water, make the connector dry. add waterproof adhesive 3. The T1B sensor failure, change a new sensor.
HR	The plate heat exchanger water outlet temperature sensor (TW_out) error.	1. The TW_out sensor connector is loosen. Reconnect it. 2.The TW_out sensor connector is wet or there is water in. remove the water, make the connector dry. add waterproof adhesive 3. The TW_out sensor failure change a new sensor.
HE	The condenser refrigerant outlet temperature is too high in heating mode for more than 10 minutes.	The outside ambient temperature is too high(higher than 30℃ , the unit still operate heat mode. close the heat mode when the ambient temperature is higher than 30℃
HF	The main control board PCB B EEPROM failure	1. The EEPROM parameter is error, rewrite the EEPROM data. 2. EEPROM chip part is broken, change a new EEPROM chip part. 3. Main PCB is broken, change a new PCB.
HH	H6 displayed 10 times in 2 hours	Refer to H6
hl	PFC module fault	Contact your local dealer
hp	Low pressure protection (Pe<0.6) occurred 3 times in an hour	Refer to P0
PD	Low pressure protection	1. System is lack of refrigerant volume. Charge the refrigerant in right volume. 2.When at heating mode or heat water mode, Heat exchanger is dirty or something is block on the surface. Clean the heat exchanger or remove the obstruction. 3. The water flow is low in cooling mode.

Error code	Malfunction or protection	Failure cause and Corrective action
<i>P0</i>	Low pressure protection	4. Electrical expansion valve locked or winding connector is loosen. Tap-tap the valve body and plug in/ plug off the connector for several times to make sure the valve is working correctly. And install the winding in the right location
<i>P1</i>	High pressure protection	Heating mode, DHW mode: 1. The water flow is low; water temp is high, whether there is air in the water system. Release the air. 2. Water pressure is lower than 0.1Mpa, charge the water to let the pressure in the range of 0.15~0.2Mpa. 3. Over charge the refrigerant volume. Recharge the refrigerant in right volume. 4. Electrical expansion valve locked or winding connector is loosen. Tap-tap the valve body and plug in/ plug off the connector for several times to make sure the valve is working correctly. And install the winding in the right location DHW mode: Water tank heat exchanger is smaller than the required 1.7m ² . (10-16kW unit) or 1.4m ² (5-9kW unit) Cooling mode: 1. Heat exchanger cover is not removed. Remove it. 2. Heat exchanger is dirty or something is block on the surface. Clean the heat exchanger or remove the obstruction.
<i>P3</i>	Compressor overcurrent protection.	1. The same reason to P1. 2. Power supply voltage of the unit is low, increase the power voltage to the required range.
<i>P4</i>	High discharge temperature protection.	1. The same reason to P1. 2. System is lack of refrigerant volume. Charge the refrigerant in right volume. 3. TW_out temp sensor is loosen Reconnect it.. 4. T1 temp sensor is loosen. Reconnect it. 5. T5 temp sensor is loosen. Reconnect it.

Error code	Malfunction or protection	Failure cause and Corrective action
<i>P5</i>	High Temperature difference protection between water inlet and water outlet of the plate heat exchanger.	1. Check that all shut off valves of the water circuit are completely open. 2. Check if the water filter needs cleaning. 3. Refer to " 9.4 Charging water " 4. Make sure there is no air in the system (purge air). 5. Check on the manometer that there is sufficient water pressure. The water pressure must be >1 bar(water is cold). 6. Check that the pump speed setting is on the highest speed. 7. Make sure that the expansion vessel is not broken. 8. Check that the resistance in the water circuit is not too high for the pump. (refer to " 10.6 Setting the pump speed ").
<i>P6</i>	Module protection	1. Power supply voltage of the unit is low, increase the power voltage to the required range. 2. The space between the units is too narrow for heat exchange. Increase the space between the units. 3. Heat exchanger is dirty or something is block on the surface. Clean the heat exchanger or remove the obstruction. 4. Fan is not running. Fan motor or fan is broken, Change a new fan or fan motor. 5. Over charge the refrigerant volume. Recharge the refrigerant in right volume. 6. Water flow rate is low, there is air in system, or pump head is not enough. Release the air and reselect the pump. 7. Water outlet temp sensor is loosen or broken, reconnect it or change a new one. 8. Water tank heat exchanger is smaller than the required 1.7m ² . (10-16kW unit) or 1.4m ² (5-9kW unit)

Error code	Malfunction or protection	Failure cause and Corrective action
<i>P6</i>	Module protection	<p>9. Module wires or screws are loosen. Reconnect wires and screws. The Thermal Conductive Adhesive is dry or drop. Add some thermal conductive adhesive.</p> <p>10. The wire connection is loosen or drop. Reconnect the wire.</p> <p>11. Drive board is defective, replace a new one.</p> <p>12. if already confirm the control system has no problem, then compressor is defective, replace a new compressor.</p>
<i>P9</i>	DC fan motor protect	Contact your local dealer
<i>Pd</i>	High temperature protection of refrigerant outlet temp of condenser.	<p>1. Heat exchanger cover is not removed. Remove it.</p> <p>2. Heat exchanger is dirty or something is block on the surface. Clean the heat exchanger or remove the obstruction.</p> <p>3. There is no enough space around the unit for heat exchanging.</p> <p>4. fan motor is broken, replace a new one.</p>
<i>PL</i>	Transducer module radiator temperature too high protect	Clean the fines. If the fin is clean, contact your local dealer
<i>Pb</i>	Anti-freeze mode protection.	Unit will return to the normal operation automatically.
<i>PP</i>	Water inlet temperature is higher than water outlet in heating mode	<p>1. The water inlet/outlet sensor wire connector is loosen. Reconnect it.</p> <p>2. The water inlet/outlet (TW_in / TW_out) sensor is broken, Change a new sensor.</p> <p>3. Four-way valve is blocked. Restart the unit again to let the valve change the direction.</p> <p>4. Four-way valve is broken, change a new valve.</p>
<i>C7</i>	Transducer module temperature too high protect	Contact your local dealer
<i>C9</i>	Operate frequency unusual protect	Contact your local dealer

14 TECHNICAL SPECIFICATIONS

14.1 General

	1-phase	3-phase	1-phase
	10\12\14\16	12\14\16	5\7\9
Nominal capacity	Refer to the Technical Data		
Dimensions H x W x D	1414×1404×405mm	1414×1404×405mm	945×1210×402mm
Weight			
Net weight	162kg	177kg	99kg
Gross weight	183kg	198kg	117kg
Connections			
water inlet/outlet	G5/4"BSP	G5/4"BSP	G1"BSP
Water drain	hose nipple		
Expansion vessel			
volume	5L	5L	2L
Maximum working pressure (MWP)	8 bar	8 bar	8 bar
Pump			
Type	water cooled	water cooled	water cooled
No. of speed	3	3	3
Internal water volume	5.5L	5.5L	2.0L
Pressure relief valve water circuit	3 bar	3 bar	3 bar
Operation range - water side			
heating	+12~+60°C	+12~+60°C	+12~+60°C
cooling	+5~+25°C	+5~+25°C	+5~+25°C
Operation range - air side			
• heating	-20~+35°C	-20~+35°C	-20~+35°C
• cooling	-5~+46°C	-5~+46°C	-5~+46°C
• domestic hot water by heat pump	-20~43°C	-20~43°C	-20~43°C

14.2 Electrical specifications

	1-phase 5\7\9\10\12\14\16	3-phase 12\14\16
Standard unit (power supply via unit)		
• power supply	220-240V~ 50Hz	380-415V 3N~ 50Hz
• nominal running current		
Standard unit (power supply via unit)		
• power supply	See "9.6.5 Connection of the backup heater power supply".	
• nominal running current	See "9.6.5 Connection of the backup heater power supply".	

14.3 Important information for the used refrigerant

This product has the fluorinated gas, it is forbidden to release to air.

Refrigerant type: R410A; Volume of GWP: 2088;
GWP=Global Warming Potential

Model	Factory charge	
	Refrigerant/kg	tonnes CO ₂ equivalent
5kW	2.40	5.01
7kW	2.40	5.01
9kW	2.40	5.01
10kW	3.60	7.52
12kW	3.60	7.52
14kW	3.60	7.52
16kW	3.60	7.52

Attention:

Frequency of Refrigerant Leak Checks

- 1) For equipment that contains fluorinated greenhouse gases in quantities of 5 tonnes of CO₂ equivalent or more, but of less than 50 tonnes of CO₂ equipment, at least every 12 months, or where a leakage detection system is installed, at least every 24 months.
- 2) For equipment that contains fluorinated greenhouse gases in quantities of 50 tonnes of CO₂ equivalent or more, but of less than 500 tonnes of CO₂ equipment, at least every six months, or where a leakage detection system is installed, at least every 12 months.
- 3) For equipment that contains fluorinated greenhouse gases in quantities of 500 tonnes of CO₂ equivalent or more, at least every three months, or where a leakage detection system is installed, at least every six months.
- 4) This air-conditioning unit is a hermetically sealed equipment that contains fluorinated greenhouse gases.
- 5) Only certificated person is allowed to do installation, operation and maintenance.

说明书更改说明，此页不在菲林
monoblock外机说明书，在16125300000899的基础上更改内容。

